



# ***SETCO™ Boring/Milling Spindles***

***Motorized • Belt Driven  
Cluster • Geared***

**SETCO™**



# Table of Contents

<b>How to Order</b> .....	3
Boring/Milling Spindle Selection Chart .....	4-5
Standard Features .....	6
Application Photos .....	7
<b>4300B Series Boring Spindles</b>	
4301B-4303B .....	8
4304B-4307B .....	9
4308B-4311B .....	10
4312B-4315B .....	11
<b>SP-Series (Parker Majestic Equivalent)</b>	
SP01B-SP03B .....	12
SP04B-SP09B .....	13
<b>SX-Series (Ex-Cello Equivalent)</b>	
SX03B-SX09B .....	14
<b>SH-Series (Heald Equivalent)</b>	
SH03B-SH09B .....	15
<b>4200PG Series—Parallel Gear Spindles</b>	
Dimensional Drawing and 4208PG .....	16
4210PG-4218PG .....	17
<b>4200WG Series—Worm Gear Spindles</b>	
Dimensional Drawing and 4213WG .....	18
4214WG-4218WG .....	19
<b>4300M Series Milling Spindles</b>	
4302M-4304M .....	20
4305M-4308M .....	21
<b>RM Series—Worm Gear Milling Spindles</b>	
Dimensional Drawing and HP/Speed Ratings .....	22
RM2-5—RM10-10 .....	23
<b>RA Series—Right Angle Milling Attachments</b>	
Dimensional Drawing and HP/Speed Ratings .....	24
Application Photos .....	25
<b>Alternate Spindle Housings—Boring and Milling</b> .....	26-27
<b>4300XRB—Series Co-Axial Spindles</b> .....	28
<b>4200MGQ Series—Heavy Duty Aerospace Milling Spindles</b>	
4210MGQ-4213MGQ .....	29
<b>6100B/M Series—Motorized Milling and Boring</b> .....	30-31
<b>6100MLC Series—Liquid Cooled Motorized Milling</b> .....	32-33
<b>16100MLC Series—High Speed Milling/Drilling/Routing</b> .....	34-35
<b>6100D Series—Dovetail Adjustable Motorized Spindles</b> .....	36
<b>Alternate Nose Designs</b> .....	37
<b>Cluster Spindles</b> .....	38-39
<b>Spindle Accessories</b> .....	40-42
<b>Application Photos</b> .....	43
<b>Engineering Section</b> .....	44-45
<b>Application Photos</b> .....	46
<b>Catalog Selection/Description and District Office Listing</b> .....	48



# How To Order

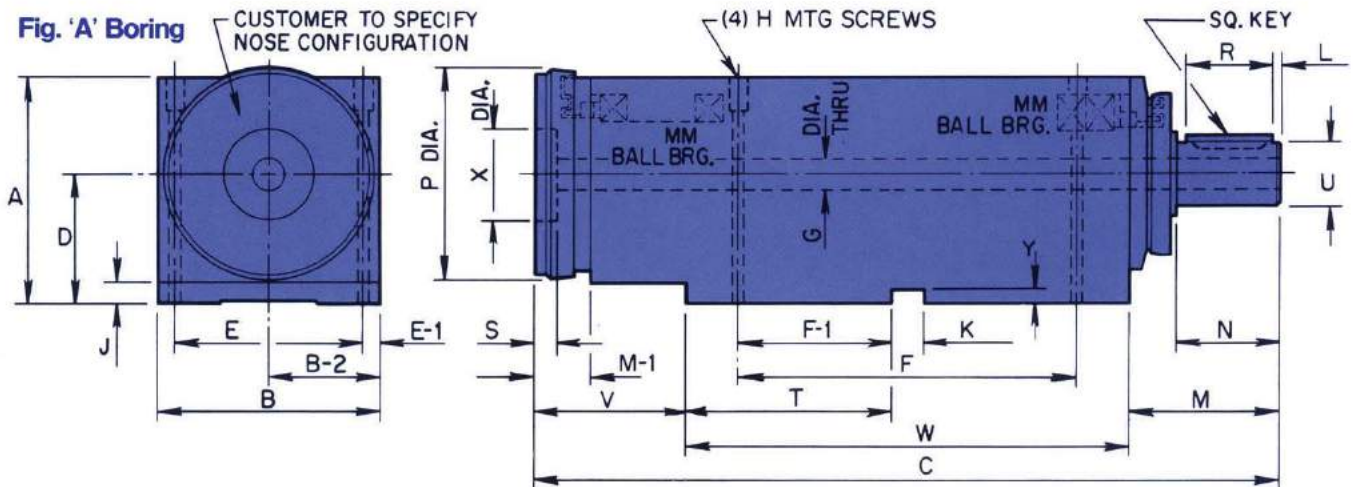

There are four ways to order a SETCO Precision Spindle:

**I Make your selection from the chart on pages 4 and 5.**

Specify the (a) quantity of spindles required, (b) SETCO type number, (c) RPM at which spindle will be operated, (d) spindle mounting position (horizontal, angular, vertical nose up or vertical nose down), (e) list any optional equipment or accessories, (f) any special dimensions required—specify by letter reference from Fig. 'A' Boring or Fig. 'B' Milling.

**II Let SETCO's Proposal Engineering Department select the spindle to meet with your exact application.**

It is very important that all pertinent information be submitted with your request; specifically (a) type of operation to be performed (furnish tool layout, sketch and/or part print), (b) diameter and length of surface to be machined, (c) stock removed, (d) rough—semi-finish or finishing operation, (e) spindle RPM, (f) horsepower required by operation, (g) spindle mounting position (horizontal, angular, vertical nose up or vertical nose down), (h) type of

drive, (i) space available for mounting spindle (width, center height, length, center distance between spindles).

III Quotations on Special Spindles—when no standard spindle shown in the catalog meets with your exact requirements, (a) include all the information required above for assisting SETCO's Proposal Engineers in the selection OR (b) furnish a sketch illustrating your application OR (c) reference a similar standard type with modification noting changes by letter designations for each change (use letter drawing above or below).

IV When replacing any SETCO Spindle Assembly, (a) specify the **serial number of the spindle to be replaced**, (b) its style or type number, (c) spindle speed (d) drawing number, etc.... The new SETCO Spindle styles are interchangeable with earlier models.

**Fig. 'B' Milling**

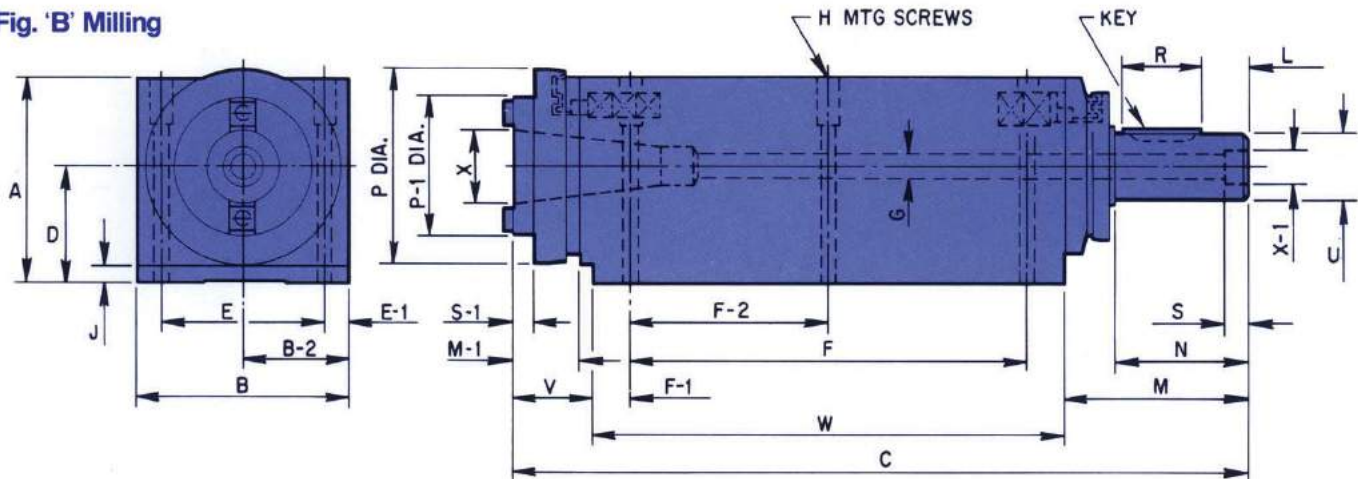





# Boring/Milling Spindle

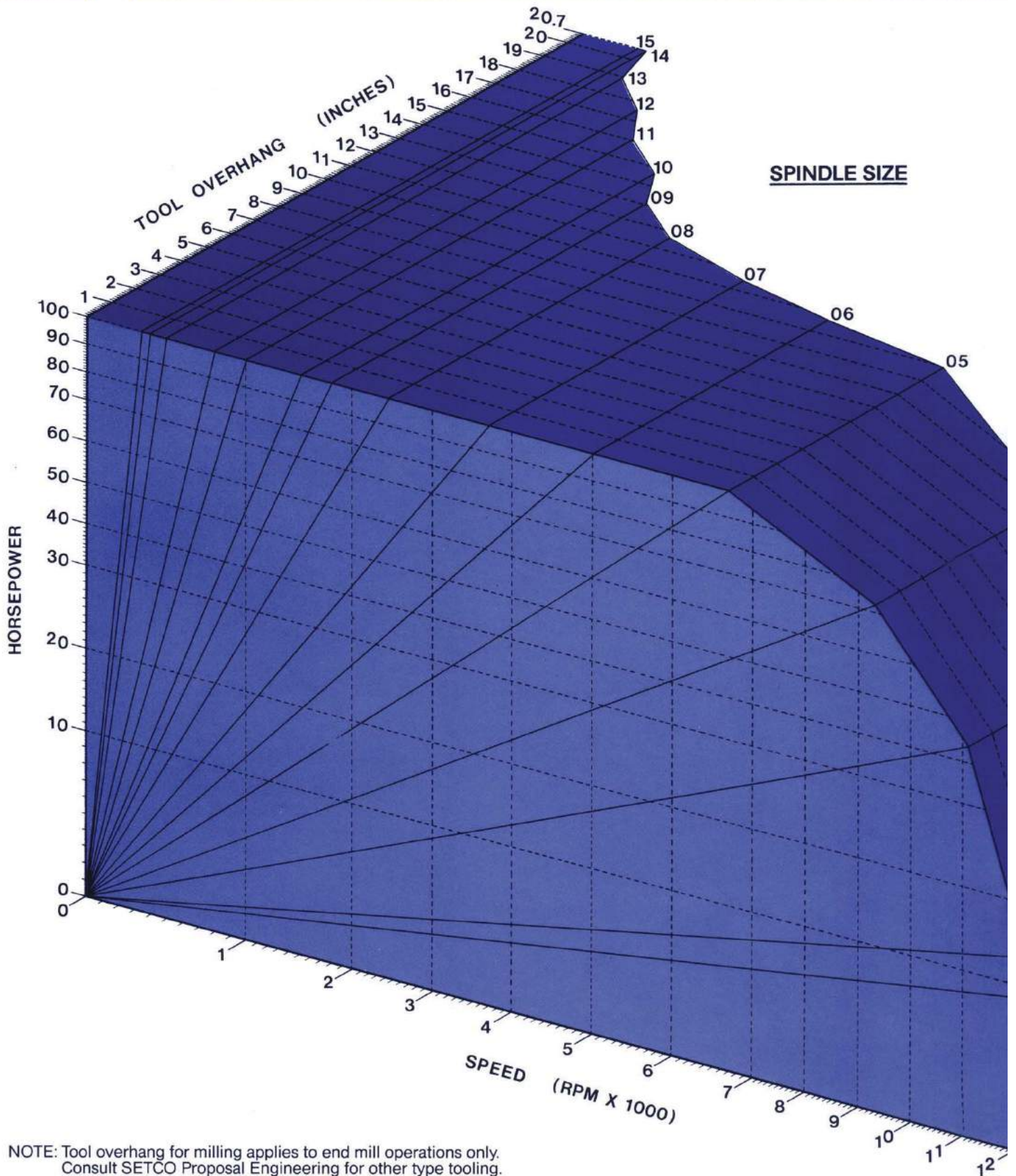

NOTE: Tool overhang for milling applies to end mill operations only.  
Consult SETCO Proposal Engineering for other type tooling.



# Selection Chart

## CHART BASED ON THE FOLLOWING SPINDLE CHARACTERISTICS:

1. Standard Boring/Milling Spindles—4300B/M SERIES
2. Ball bearing construction on Sizes 01 through 12 — roller bearing construction 13 through 15
3. No rubbing seals
4. Grease lubrication
5. Tool overhang from spindle nose
6. Independent of housing type. Spindle size selection based on HP vs. RPM and/or tool overhang.
7. (Bearing Bore size must be considered when selecting a spindle size.) A general rule is that Spindle Nose Bearing Bore should be approximately as large or larger than the bore to be machined whenever possible.

**Example No. 1:** Customer's boring operation requires 30 HP at 5000 RPM with 5.0 in. tool overhang, part bore size less than 2.75" dia. Selection procedure:

1. Locate 5000 RPM on chart and follow up to intersection with 30 HP
2. Falls within the 05B Spindle Size
3. Check tool overhang — locate 5.0 in. tool overhang on chart and follow along to the 05B Spindle Size (05B has 70 mm Bore Brg.) — falls within limitation of the 05B Size
4. Therefore, an 05B is recommended for customer's operation

**Example No. 2:** Customer's boring operation requires 30 HP at 5000 RPM with 5.0 in. tool overhang, part bore size 3.000" in diameter.

1. Locate 5000 RPM on chart and follow up to intersection with 30 HP
2. Falls within the 05B Spindle Size
3. Check tool overhang—locate 5.0" tool overhang on chart and follow along to the 05B Spindle Size (05B has 70 mm Bore Brg.) Note: 3.000" dia. exceeds 05B Bearing Bore.
4. Therefore, an 06B is recommended for customer's operation (06B has 75 mm Bore Brg.)

**Example No. 3:** Customer's end milling operation requires 5 HP at 500 RPM with 4.0 in. tool overhang, end mill diameters 2.0 in.

Selection Procedure:

1. Locate 500 RPM on chart and follow up to intersection with 5 HP.
2. Falls within the 06M spindle size.
3. Check tool overhang—locate 4.0 in. tool overhang on chart and follow along to the 06M spindle size—falls within limitation of the 06M size.
4. Therefore, an 06M is recommended for customer's operation.

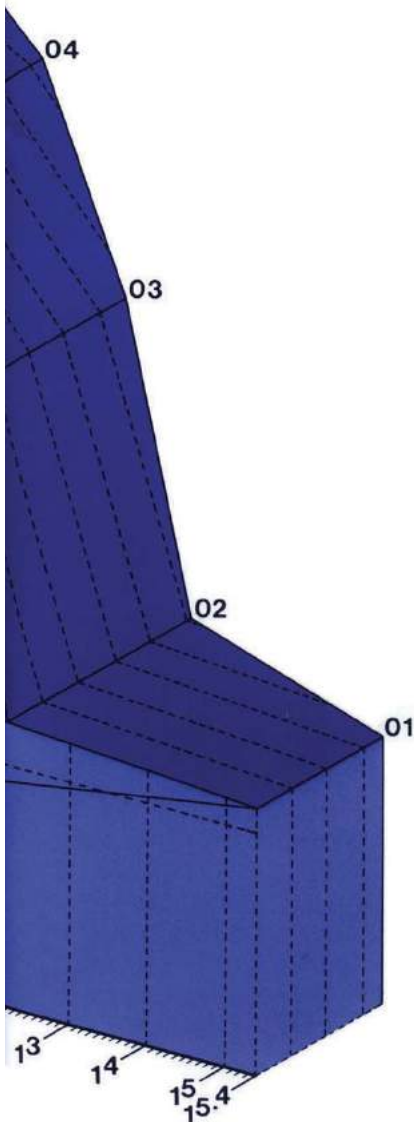





# Standard Features

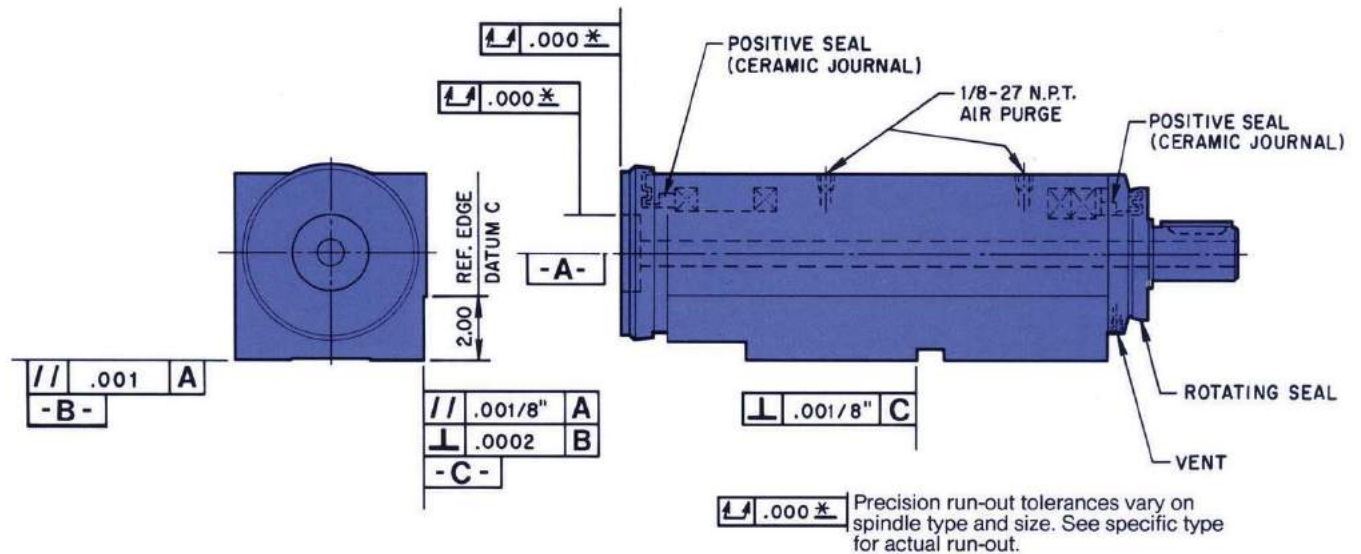

1. Spindles arranged for reversible rotation
2. Air purge, front and rear, 1/8-27 NPT inlets
3. Positive rubbing seal with ceramic journal (front and rear) when S.F.P.M. permits
4. Maze labyrinth seal (front and rear) when rubbing seals are not possible because of high seal journal velocity
5. Enveloping shroud (front and rear) for maximum protection against contamination
6. Bearings are permanently grease lubricated
7. Vibrometer reading .000050 maximum
8. Heavy duty anti-friction Angular Contact ABEC-7 Extra Precision ball bearing
9. Hollow spindle for coolant or drawbar (tooling operating mechanisms)
10. Spindle flange with precision O.D. face and I.D. locating surfaces drilled and tapped to user requirements (boring only)
11. Std. NMTBA milling noses
12. Cross keyway in housing (optional on milling)
13. Right hand edge of base machined parallel with spindle centerline for reference
14. Straight locating surface with square key is provided for drive pulleys
15. Spindle arbor is a one piece heat treated and finish ground forging
16. Heavy, rugged 40,000 P.S.I. tensil gray iron housing, stress relieved and properly normalized to minimize distortion.
17. Each spindle registered with SETCO's exclusive Gold Line TCT Certificate verifying tested performance.

## SETCO'S UNIQUE POSITIVE SEAL DESIGN

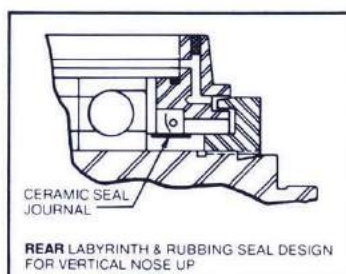
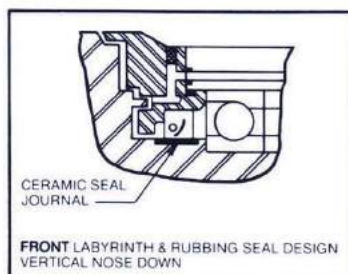
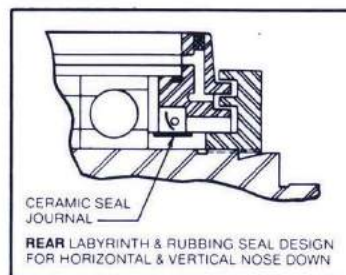
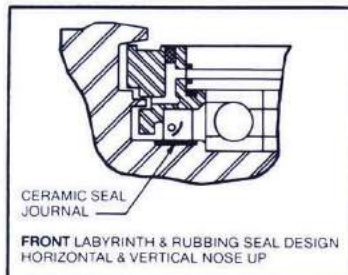



# Application Photos

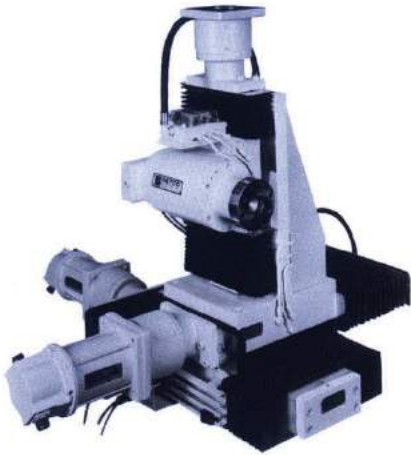

**Photo #4094**  
Three axis precision dovetail assembly with a standard 6101-18B Motorized Boring Spindle rated 1 H.P. at 1800 R.P.M. Complete assembly arranged with plumbing and manifold valves for automatic lubrication to slides. Direct coupled servo motors, ball screws, limit switches and bellows are included.



**Photo #4051**  
Type 6250-36/18MLC-PD Two Speed Heavy Duty Motorized Milling Spindle rated 50/25 H.P. at 3600/1800 R.P.M. and arranged for continuous duty with constant torque. Milling spindle includes bayonet type power draw bar assembly and vari-load adjustable preload bearings.



**Photo #3967**  
Type 4307B-Y Boring Spindle Assembly arranged with an A2-5" lathe nose, special front nose extension and multiple keyways.



**Photo #4048**  
Type 4303M Milling Spindle with universal 'Kwik-Switch' nose and integral motor mounting arrangement with a 2:1 ratio drive and servo motor. Spindle mounted to riser block and 8" wide dovetail slide with ball screw and servo drive package.



**Photo #3992**  
Type 4206B-Y Precision Foot Mounted Boring Spindle Assembly arranged with a special nose construction to adapt a Type 2RA-Y Right Angle Milling Head with a #40 NMTB nose.

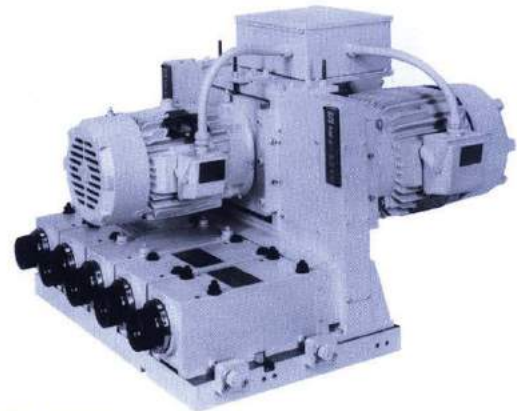
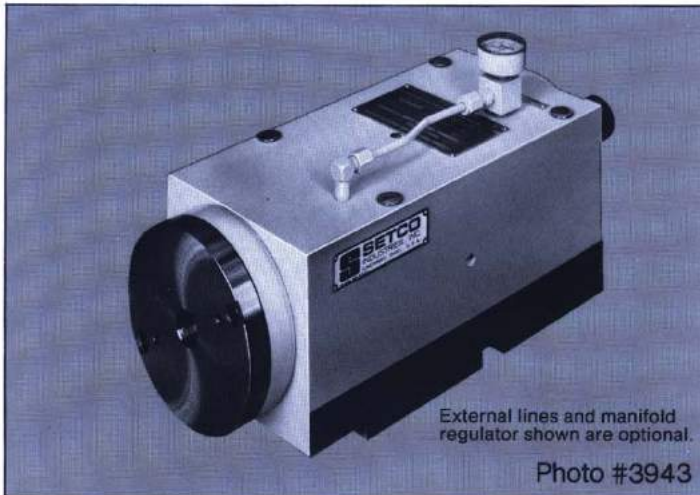

**PHOTO #4105**  
This multiple cluster milling assembly includes five Type 4304MY Spindle Assemblies with Universal "Kwik-Switch" tooling noses, adjustable throw blocks and integral belt guard motor mounting arrangement with three separate motor drives. Complete assembly is precision keyed and sub-plate mounted and includes large conduit box with quick disconnect plug for operating with A.C. variable frequency control.





# 4300B SERIES - Boring Spindles



The special heavy duty bearing construction makes SETCO Super Precision Boring Spindles ideal for radial and axial thrust loads normally associated with single and multiple point boring tools.

These spindles are available for stacked clusters as shown on page 39, photo #3755 and with alternate spindle housings as shown on pages 26 and 27. Optional nose designs are illustrated on page 37.

Reference pages 6 and 7 for the standard features and lettered dimensions. Spindles can be modified to meet with your exact requirements.

The Bearing Sizes shown on each 4300B Series Boring Spindle reflect the exact O.D. shaft size.

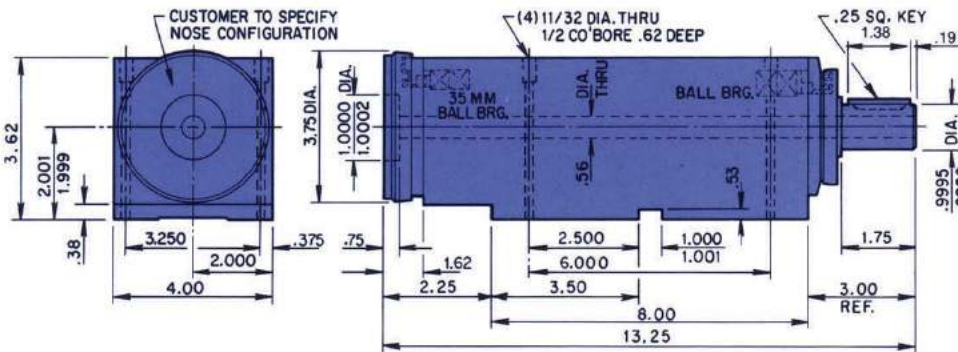

## 4301B

1. Operating Speed—Grease Lubrication  
3700 RPM Max. With Rubbing Seals  
15300 RPM Max. With Labyrinth Seals  
26100 RPM Max. With Oil Mist Lubrication
2. Max. Torque Rating—60 in./lbs.  
1/1000 H.P./Rev. [.001]
3. Run-Out Tolerances  
Mounting Face .0001 T.I.R. Max.  
Pilot Dia. .0001 T.I.R. Max.
4.  $wk^2=7$  lbs. in<sup>2</sup>
5. Weight Approx. 45 lbs.

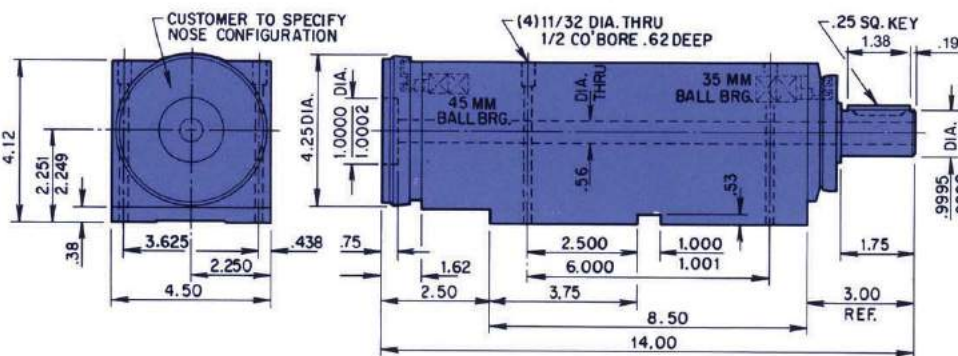

## 4302B

1. Operating Speed—Grease Lubrication  
3000 RPM Max. With Rubbing Seals  
12000 RPM Max. With Labyrinth Seals  
20000 RPM Max. With Oil Mist Lubrication
2. Max. Torque Rating—70 in./lbs.  
1/900 H.P./Rev. [.001]
3. Run-Out Tolerances  
Mounting Face .0001 T.I.R. Max.  
Pilot Dia. .0001 T.I.R. Max.
4.  $wk^2=13$  lbs. in<sup>2</sup>
5. Weight Approx. 60 lbs.

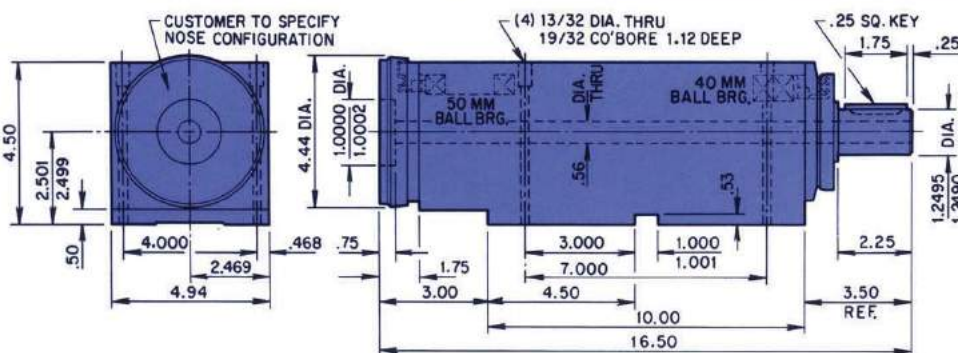

## 4303B

1. Operating Speed—Grease Lubrication  
2800 RPM Max. With Rubbing Seals  
11100 RPM Max. With Labyrinth Seals  
18800 RPM Max. With Oil Mist Lubrication
2. Max. Torque Rating—175 in./lbs.  
1/350 H.P./Rev. [.0028]
3. Run-Out Tolerances  
Mounting Face .0001 T.I.R. Max.  
Pilot Dia. .0001 T.I.R. Max.
4.  $wk^2=18$  lbs. in<sup>2</sup>
5. Weight Approx. 80 lbs.



# - Boring Spindles

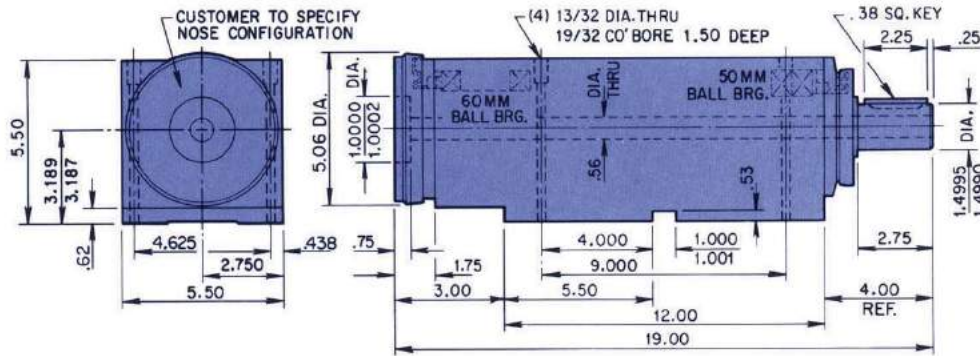

## 4304B

1. Operating Speed—Grease Lubrication  
2200 RPM Max. With Rubbing Seals  
9300 RPM Max. With Labyrinth Seals  
15800 RPM Max. With Oil Mist Lubrication
2. Max. Torque Rating—500 in./lbs.  
1/125 H.P./Rev. [.008]
3. Run-Out Tolerances  
Mounting Face .0001 T.I.R. Max.  
Pilot Dia. .0001 T.I.R. Max.
4.  $wk^2=33$  lbs. in<sup>2</sup>
5. Weight Approx. 125 lbs.

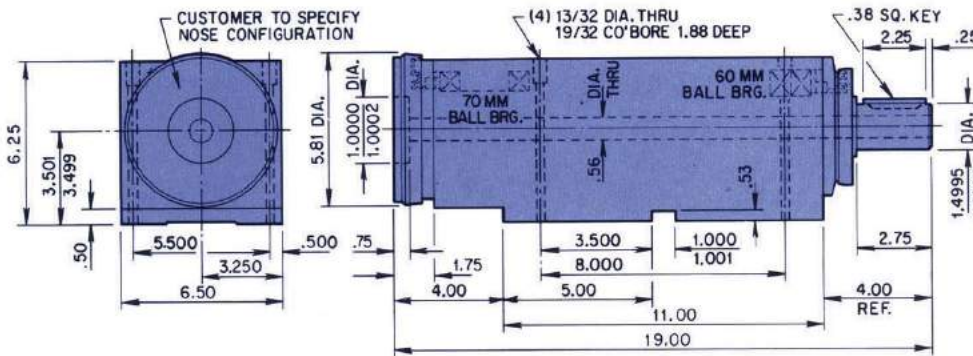

## 4305B

1. Operating Speed—Grease Lubrication  
1900 RPM Max. With Rubbing Seals  
8000 RPM Max. With Labyrinth Seals  
13600 RPM Max. With Oil Mist Lubrication
2. Max. Torque Rating—950 in./lbs.  
1/60 H.P./Rev. [.0166]
3. Run-Out Tolerances  
Mounting Face .0001 T.I.R. Max.  
Pilot Dia. .0001 T.I.R. Max.
4.  $wk^2=61$  lbs. in<sup>2</sup>
5. Weight Approx. 175 lbs.

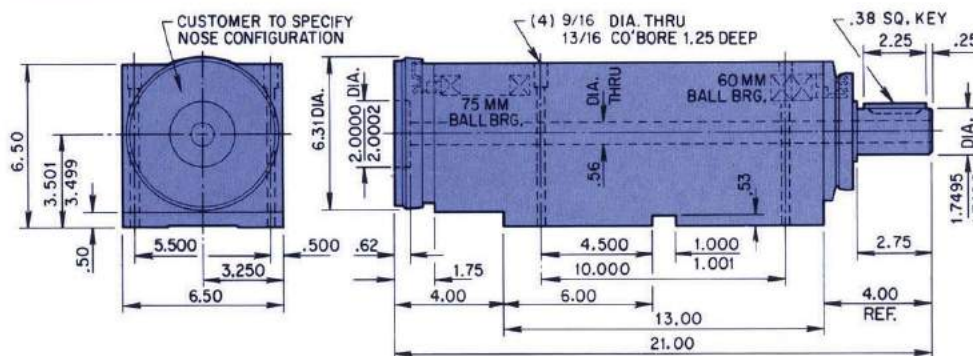

## 4306B

1. Operating Speed—Grease Lubrication  
1900 RPM Max. With Rubbing Seals  
7500 RPM Max. With Labyrinth Seals  
12700 RPM Max. With Oil Mist Lubrication
2. Max. Torque Rating—1275 in./lbs.  
1/50 H.P./Rev. [.02]
3. Run-Out Tolerances  
Mounting Face .0002 T.I.R. Max.  
Pilot Dia. .0002 T.I.R. Max.
4.  $wk^2=84$  lbs. in<sup>2</sup>
5. Weight Approx. 200 lbs.

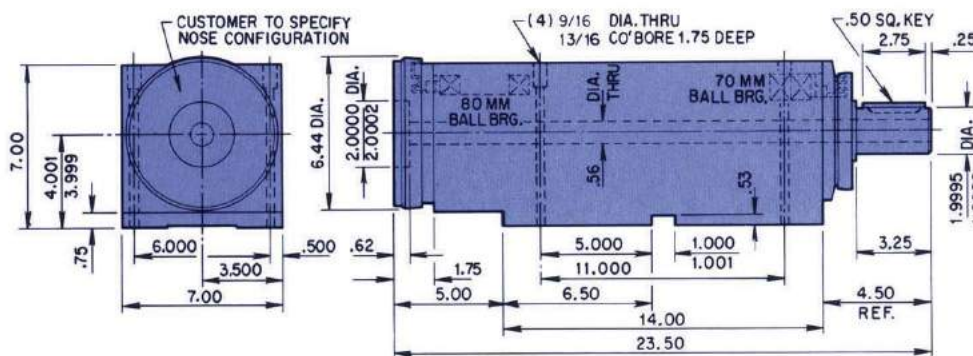

## 4307B

1. Operating Speed—Grease Lubrication  
1700 RPM Max. With Rubbing Seals  
7000 RPM Max. With Labyrinth Seals  
11900 RPM Max. With Oil Mist Lubrication
2. Max. Torque Rating—1700 in./lbs.  
1/40 H.P./Rev. [.025]
3. Run-Out Tolerances  
Mounting Face .0002 T.I.R. Max.  
Pilot Dia. .0002 T.I.R. Max.
4.  $wk^2=104$  lbs. in<sup>2</sup>
5. Weight Approx. 250 lbs.





# 4300B SERIES - Boring Spindles

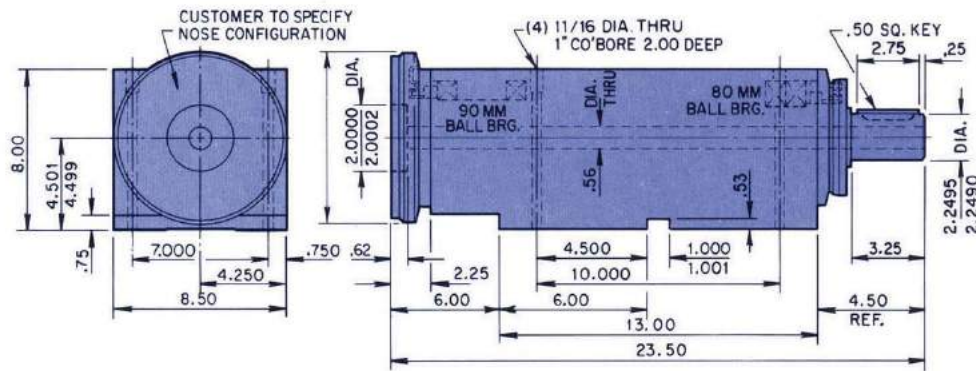

## 4308B

1. Operating Speed—Grease Lubrication  
1500 RPM Max. With Rubbing Seals  
6200 RPM Max. With Labyrinth Seals  
10600 RPM Max. With Oil Mist Lubrication
2. Max. Torque Rating—2600 in./lbs.  
1/25 H.P./Rev. [.04]
3. Run-Out Tolerances  
Mounting Face .0002 T.I.R. Max.  
Pilot Dia. .0002 T.I.R. Max.
4.  $wk^2=281$  lbs. in<sup>2</sup>
5. Weight Approx. 350 lbs.

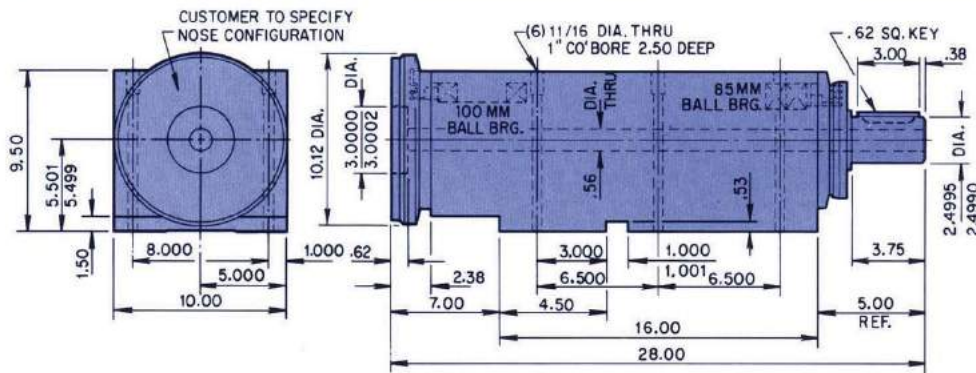

## 4309B

1. Operating Speed—Grease Lubrication  
1400 RPM Max. With Rubbing Seals  
5600 RPM Max. With Labyrinth Seals  
9600 RPM Max. With Oil Mist Lubrication
2. Max. Torque Rating—3550 in./lbs.  
1/20 H.P./Rev. [.05]
3. Run-Out Tolerances  
Mounting Face .0002 T.I.R. Max.  
Pilot Dia. .0002 T.I.R. Max.
4.  $wk^2=652$  lbs. in<sup>2</sup>
5. Weight Approx. 600 lbs.

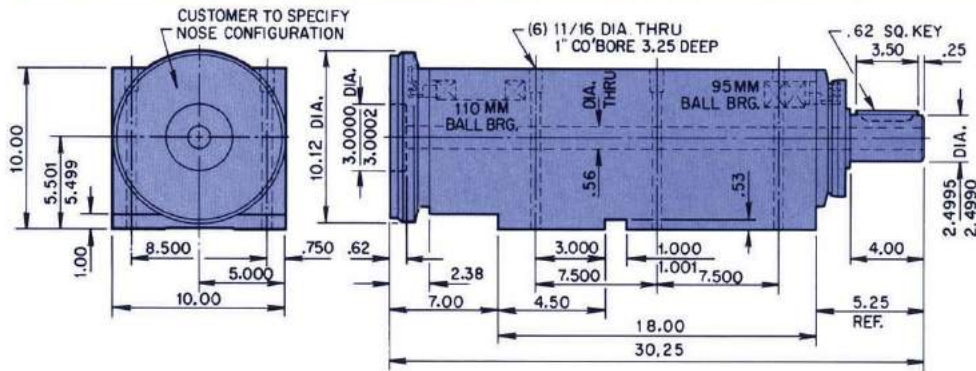

## 4310B

1. Operating Speed—Grease Lubrication  
1300 RPM Max. With Rubbing Seals  
5100 RPM Max. With Labyrinth Seals  
8600 RPM Max. With Oil Mist Lubrication
2. Max. Torque Rating—4250 in./lbs.  
1/15 H.P./Rev. [.0666]
3. Run-Out Tolerances  
Mounting Face .0002 T.I.R. Max.  
Pilot Dia. .0002 T.I.R. Max.
4.  $wk^2=732$  lbs. in<sup>2</sup>
5. Weight Approx. 675 lbs.

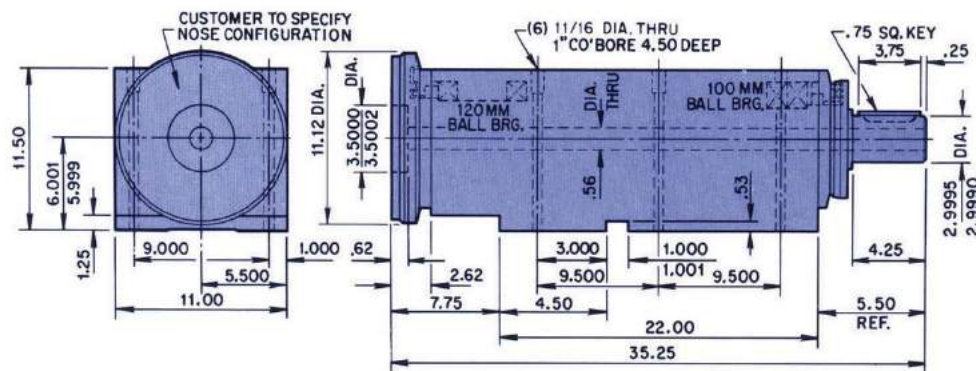

## 4311B

1. Operating Speed—Grease Lubrication  
1200 RPM Max. With Rubbing Seals  
4700 RPM Max. With Labyrinth Seals  
8000 RPM Max. With Oil Mist Lubrication
2. Max. Torque Rating—6350 in./lbs.  
1/10 H.P./Rev. [.10]
3. Run-Out Tolerances  
Mounting Face .0002 T.I.R. Max.  
Pilot Dia. .0002 T.I.R. Max.
4.  $wk^2=1216$  lbs. in<sup>2</sup>
5. Weight Approx. 1025 lbs.



# - Boring Spindles

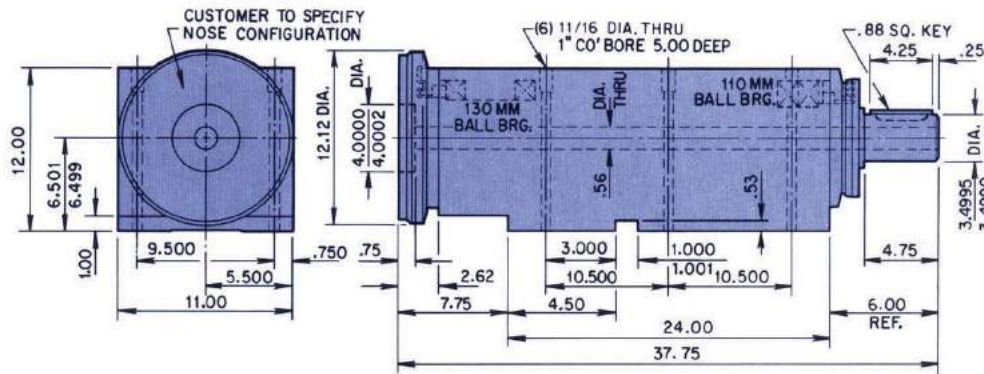

## 4312B

1. Operating Speed—Grease Lubrication  
1000 RPM Max. With Rubbing Seals  
4300 RPM Max. With Labyrinth Seals  
7300 RPM Max. With Oil Mist Lubrication
2. Max. Torque Rating—7950 in./lbs.  
1/8 H.P./Rev. [.125]
3. Run-Out Tolerances  
Mounting Face .0003 T.I.R. Max.  
Pilot Dia. .0003 T.I.R. Max.
4.  $wk^2 = 1753 \text{ lbs. in}^2$
5. Weight Approx. 1125 lbs.

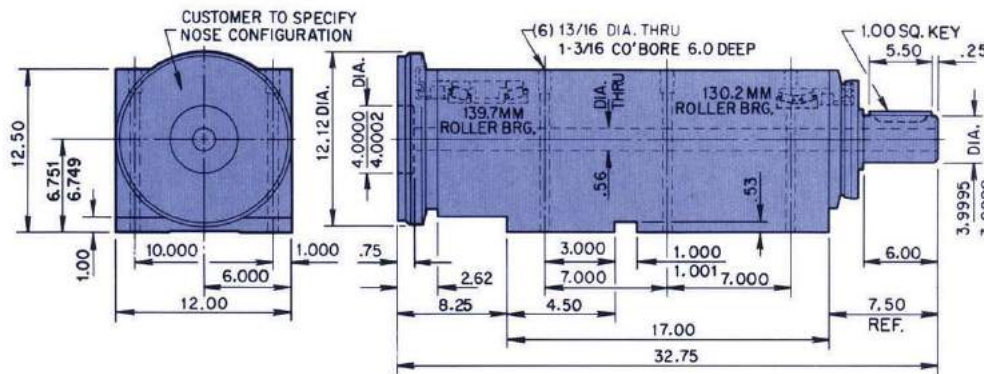

## 4313B

1. Operating Speed—Grease Lubrication  
1000 RPM Max. With Rubbing Seals  
1500 RPM Max. With Labyrinth Seals
2. Max. Torque Rating—12700 in./lbs.  
1/5 H.P./Rev. [.20]
3. Run-Out Tolerances  
Mounting Face .0004 T.I.R. Max.  
Pilot Dia. .0004 T.I.R. Max.
4.  $wk^2 = 1858 \text{ lbs. in}^2$
5. Weight Approx. 1050 lbs.

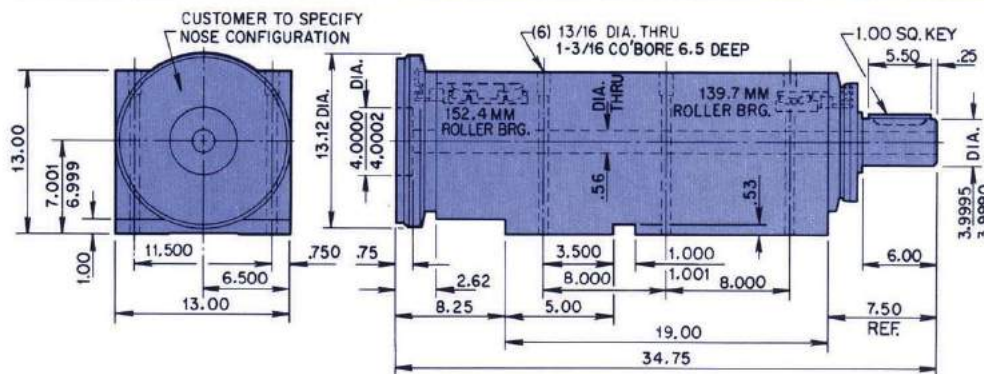

## 4314B

1. Operating Speed—Grease Lubrication  
900 RPM Max. With Rubbing Seals  
1100 RPM Max. With Labyrinth Seals
2. Max. Torque Rating—15900 in./lbs.  
1/4 H.P./Rev. [.25]
3. Run-Out Tolerances  
Mounting Face .0004 T.I.R. Max.  
Pilot Dia. .0004 T.I.R. Max.
4.  $wk^2 = 2601 \text{ lbs. in}^2$
5. Weight Approx. 1125 lbs.

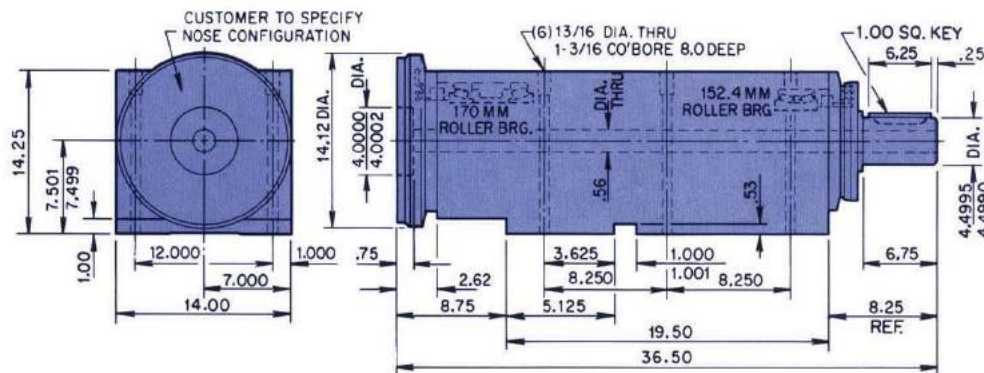

## 4315B

1. Operating Speed—Grease Lubrication  
800 RPM Max. With Rubbing Seals  
1050 RPM Max. With Labyrinth Seals
2. Max. Torque Rating—18400 in./lbs.  
2/7 H.P./Rev. [.2857]
3. Run-Out Tolerances  
Mounting Face .0004 T.I.R. Max.  
Pilot Dia. .0004 T.I.R. Max.
4.  $wk^2 = 3695 \text{ lbs. in}^2$
5. Weight Approx. 1400 lbs.





# SP SERIES - Parker Majestic Equivalent

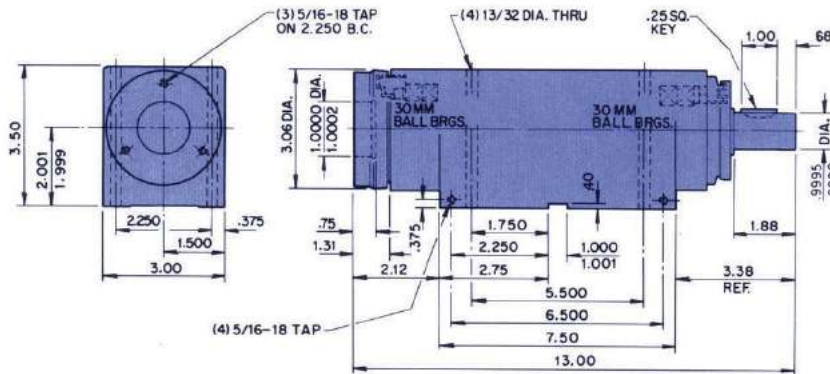

Photo #3793

These spindles are manufactured to the same high quality standards as the 4300B Series Spindles shown on page 8. The only difference from the 4300B Series is a Solid Arbor. The base mounting configuration and centerline heights are designed for interchanging with and for replacement of Parker Majestic Spindles.

Additional belt driven and motorized spindles are available for direct interchange with all new and old style Parker Majestic Spindles. Include model and/or type with inquiry.

The Bearing Sizes shown on each SP Series Boring Spindle reflect the exact O.D. shaft size.



## SPO1B (P.M. 1295)

1. Operating Speed—Grease Lubrication  
4400 RPM Max. With Rubbing Seals  
17600 RPM Max. With Labyrinth Seals  
29900 RPM Max. With Oil Mist Lubrication
2. Max. Torque Rating—50 in./lbs.  
1/1250 H.P./Rev. [.0008]
3. Run-Out Tolerances  
Mounting Face .0001 T.I.R. Max.  
Pilot Dia. .0001 T.I.R. Max.
4.  $wk^2=4$  lbs. in<sup>2</sup>
5. Weight Approx. 30 lbs.

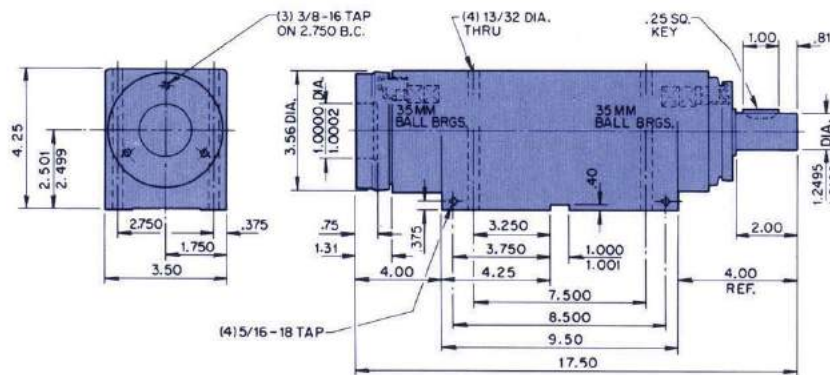

## SPO2B (P.M. 2483)

1. Operating Speed—Grease Lubrication  
3700 RPM Max. With Rubbing Seals  
15300 RPM Max. With Labyrinth Seals  
26100 RPM Max. With Oil Mist Lubrication
2. Max. Torque Rating—60 in./lbs.  
1/1000 H.P./Rev. [.001]
3. Run-Out Tolerances  
Mounting Face .0001 T.I.R. Max.  
Pilot Dia. .0001 T.I.R. Max.
4.  $wk^2=8$  lbs. in<sup>2</sup>
5. Weight Approx. 55 lbs.

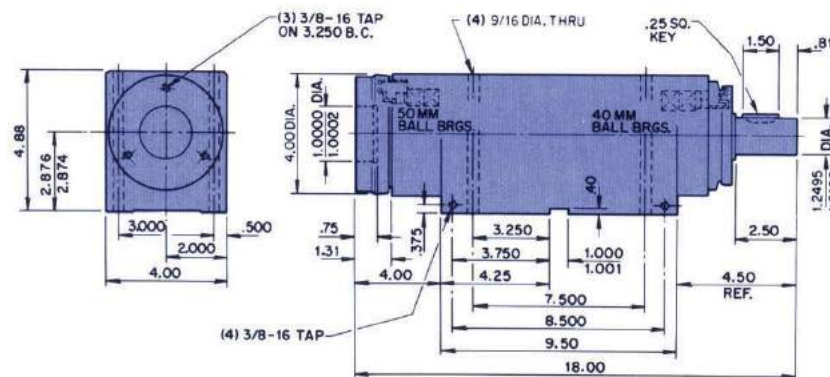

## SPO3B (P.M. 2313)

1. Operating Speed—Grease Lubrication  
2800 RPM Max. With Rubbing Seals  
11100 RPM Max. With Labyrinth Seals  
18800 RPM Max. With Oil Mist Lubrication
2. Max. Torque Rating—175 in./lbs.  
1/350 H.P./Rev. [.0028]
3. Run-Out Tolerances  
Mounting Face .0001 T.I.R. Max.  
Pilot Dia. .0001 T.I.R. Max.
4.  $wk^2=14$  lbs. in<sup>2</sup>
5. Weight Approx. 70 lbs.



# - Parker Majestic Equivalent

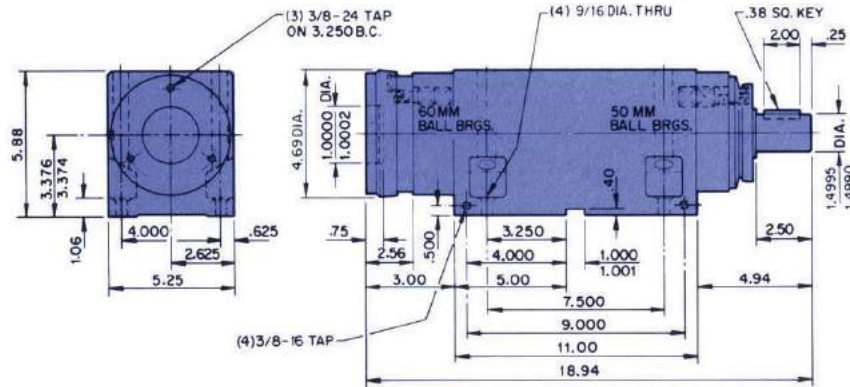

## SP04B (P.M. 1291)

1. Operating Speed—Grease Lubrication  
2200 RPM Max. With Rubbing Seals  
9300 RPM Max. With Labyrinth Seals  
15800 RPM Max. With Oil Mist Lubrication
2. Max. Torque Rating—500 in./lbs.  
1/125 H.P./Rev. [.008]
3. Run-Out Tolerances  
Mounting Face .0001 T.I.R. Max.  
Pilot Dia. .0001 T.I.R. Max.
4.  $wk^2=44$  lbs. in<sup>2</sup>
5. Weight Approx. 135 lbs.

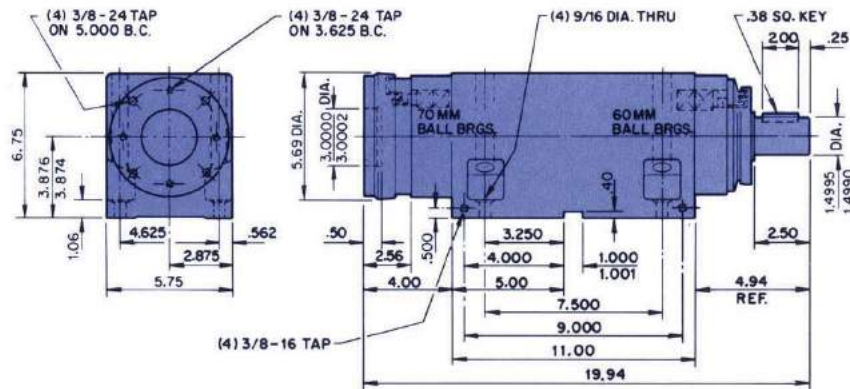

## SP05B (P.M. 1292)

1. Operating Speed—Grease Lubrication  
1900 RPM Max. With Rubbing Seals  
8000 RPM Max. With Labyrinth Seals  
13600 RPM Max. With Oil Mist Lubrication
2. Max. Torque Rating—950 in./lbs.  
1/60 H.P./Rev. [.0166]
3. Run-Out Tolerances  
Mounting Face .0001 T.I.R. Max.  
Pilot Dia. .0001 T.I.R. Max.
4.  $wk^2=93$  lbs. in<sup>2</sup>
5. Weight Approx. 170 lbs.

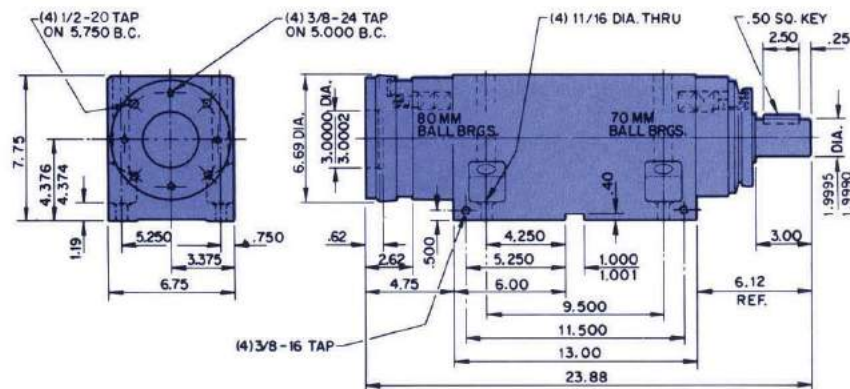

## SP07B (P.M. 1293)

1. Operating Speed—Grease Lubrication  
1700 RPM Max. With Rubbing Seals  
7000 RPM Max. With Labyrinth Seals  
11900 RPM Max. With Oil Mist Lubrication
2. Max. Torque Rating—1700 in./lbs.  
1/40 H.P./Rev. [.025]
3. Run-Out Tolerances  
Mounting Face .0002 T.I.R. Max.  
Pilot Dia. .0002 T.I.R. Max.
4.  $wk^2=187$  lbs. in<sup>2</sup>
5. Weight Approx. 270 lbs.

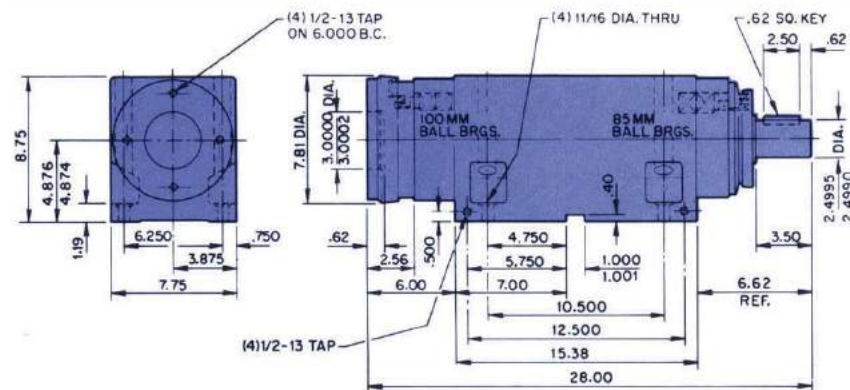

## SP09B (P.M. 2377)

1. Operating Speed—Grease Lubrication  
1400 RPM Max. With Rubbing Seals  
5600 RPM Max. With Labyrinth Seals  
9600 RPM Max. With Oil Mist Lubrication
2. Max. Torque Rating—3550 in./lbs.  
1/20 H.P./Rev. [.05]
3. Run-Out Tolerances  
Mounting Face .0002 T.I.R. Max.  
Pilot Dia. .0002 T.I.R. Max.
4.  $wk^2=380$  lbs. in<sup>2</sup>
5. Weight Approx. 410 lbs.





# SX SERIES - Boring Spindles Ex-Cello Equivalent

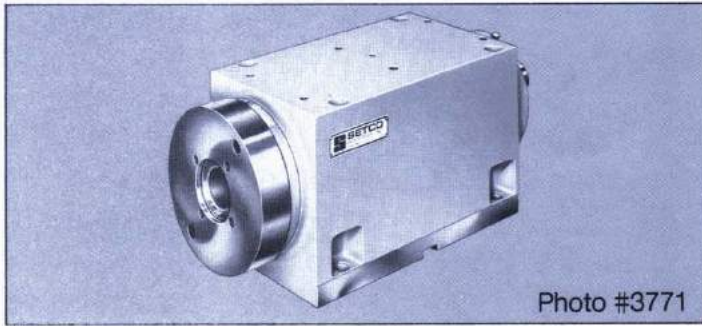

Photo #3771

These spindles are manufactured to the same high quality standards as the 4300B Series Spindles shown on page 8. The only difference from the 4300B Series is in the base mounting configuration and centerline heights for interchanging with and for replacement of Ex-Cello Spindles.

Additional belt driven and motorized spindles are available for direct interchange with all new and old style Ex-Cello Spindles. Include model and/or type with inquiry.

The Bearing Sizes shown on each SX Series Boring Spindle reflect the exact O.D. shaft size.

## SX03B XLB101 (DB22)

1. Operating Speed—Grease Lubrication  
2800 RPM Max. With Rubbing Seals  
11100 RPM Max. With Labyrinth Seals  
18800 RPM Max. With Oil Mist Lubrication
2. Max. Torque Rating—175 in./lbs.  
1/350 H.P./Rev. [.0028]
3. Run-Out Tolerances  
Mounting Face .0001 T.I.R. Max.  
Pilot Dia. .0001 T.I.R. Max.
4.  $wk^2=16$  lbs. in<sup>2</sup>
5. Weight Approx. 100 lbs.

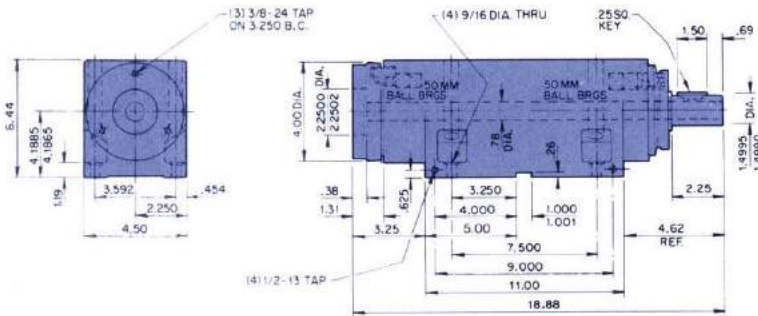

## SX07B XLB161 (DB24)

1. Operating Speed—Grease Lubrication  
1700 RPM Max. With Rubbing Seals  
7000 RPM Max. With Labyrinth Seals  
11900 RPM Max. With Oil Mist Lubrication
2. Max. Torque Rating—1700 in./lbs.  
1/40 H.P./Rev. [.025]
3. Run-Out Tolerances  
Mounting Face .0002 T.I.R. Max.  
Pilot Dia. .0002 T.I.R. Max.
4.  $wk^2=83$  lbs. in<sup>2</sup>
5. Weight Approx. 160 lbs.

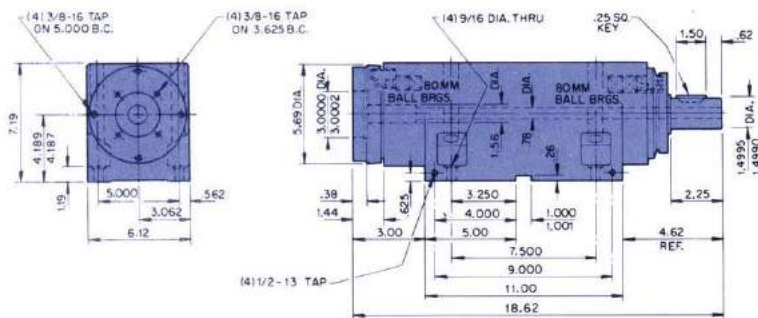

## SX09B-1 XLB201 (DB25)

1. Operating Speed—Grease Lubrication  
1400 RPM Max. With Rubbing Seals  
5600 RPM Max. With Labyrinth Seals  
9600 RPM Max. With Oil Mist Lubrication
2. Max. Torque Rating—3550 in./lbs.  
1/20 H.P./Rev. [.05]
3. Run-Out Tolerances  
Mounting Face .0002 T.I.R. Max.  
Pilot Dia. .0002 T.I.R. Max.
4.  $wk^2=373$  lbs. in<sup>2</sup>
5. Weight Approx. 270 lbs.

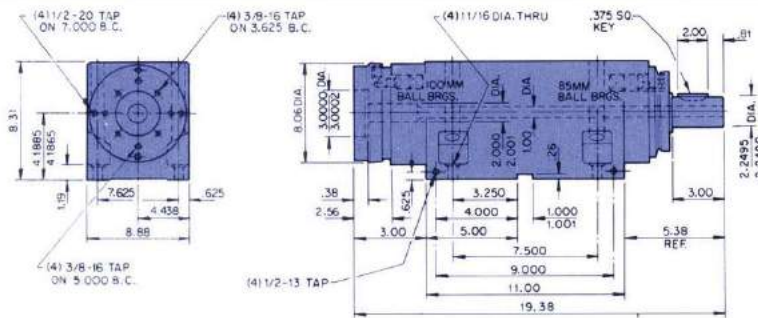

## SX09B-2 XLB202 (DB25)

1. Operating Speed—Grease Lubrication  
1400 RPM Max. With Rubbing Seals  
5600 RPM Max. With Labyrinth Seals  
9600 RPM Max. With Oil Mist Lubrication
2. Max. Torque Rating—3550 in./lbs.  
1/20 H.P./Rev. [.05]
3. Run-Out Tolerances  
Mounting Face .0002 T.I.R. Max.  
Pilot Dia. .0002 T.I.R. Max.
4.  $wk^2=390$  lbs. in<sup>2</sup>
5. Weight Approx. 400 lbs.

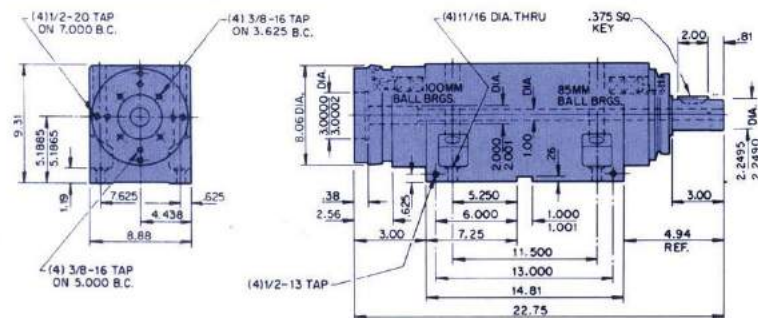



# SH SERIES - Heald Equivalent



These spindles are manufactured to the same high quality standards as the 4300B Series Spindles shown on page 8. The only difference from the 4300B Series is in the base mounting configuration and centerline heights for interchanging with and for replacement of Heald Spindles.

Additional belt driven and motorized spindles are available for direct interchange with all new and old style Heald Spindles. Include model and/or type with inquiry.

The Bearing Sizes shown on each SH Series Boring Spindle reflect the exact O.D. shaft size.

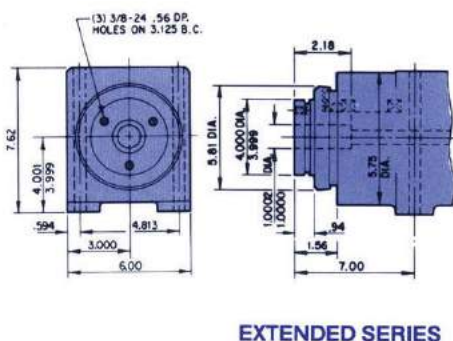

EXTENDED SERIES

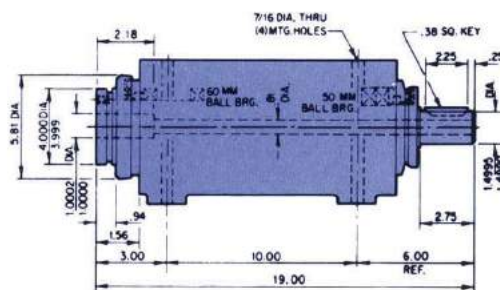

STANDARD SERIES

## SH03B 212 HEALD EQUIVALENT

1. Operating Speed—Grease Lubrication  
2100 RPM Max. With Rubbing Seals  
9300 RPM Max. With Labyrinth Seals  
15800 RPM Max. With Oil Mist Lubrication
2. Max. Torque Rating—500 in./lbs.  
1/125 H.P./Rev. [.008]
3. Run-Out Tolerances  
Mounting Face .0001 T.I.R. Max.  
Pilot Dia. .0001 T.I.R. Max.
4.  $wk^2 = 36$  lbs. in<sup>2</sup>
5. Weight Approx. 180 lbs.

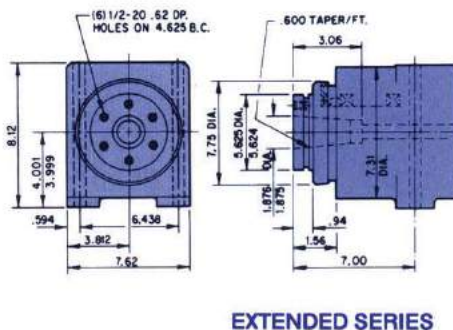

EXTENDED SERIES

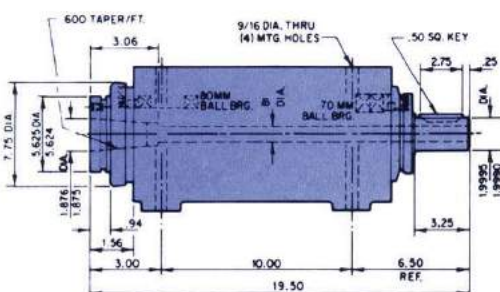

STANDARD SERIES

## SH07B 216 HEALD EQUIVALENT

1. Operating Speed—Grease Lubrication  
1600 RPM Max. With Rubbing Seals  
7000 RPM Max. With Labyrinth Seals  
11900 RPM Max. With Oil Mist Lubrication
2. Max. Torque Rating—1700 in./lbs.  
1/40 H.P./Rev. [.025]
3. Run-Out Tolerances  
Mounting Face .0002 T.I.R. Max.  
Pilot Dia. .0002 T.I.R. Max.
4.  $wk^2 = 122$  lbs. in<sup>2</sup>
5. Weight Approx. 255 lbs.

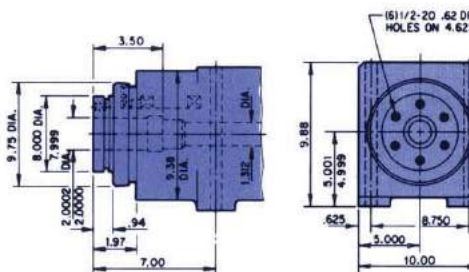

EXTENDED SERIES

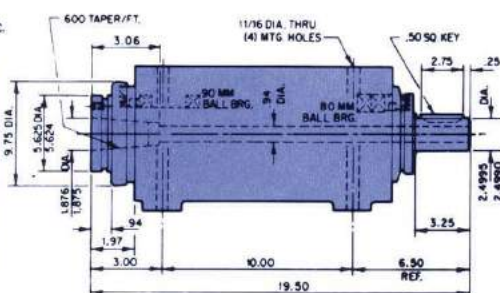

STANDARD SERIES

## SH09B 218 HEALD EQUIVALENT

1. Operating Speed—Grease Lubrication  
1400 RPM Max. With Rubbing Seals  
6000 RPM Max. With Labyrinth Seals  
10300 RPM Max. With Oil Mist Lubrication
2. Max. Torque Rating—2600 in./lbs.  
1/25 H.P./Rev. [.04]
3. Run-Out Tolerances  
Mounting Face .0002 T.I.R. Max.  
Pilot Dia. .0002 T.I.R. Max.
4.  $wk^2 = 339$  lbs. in<sup>2</sup>
5. Weight Approx. 400 lbs.

Note: Type SH09B extended series has a spindle face hole pattern of  $\frac{1}{8}$ -18 TAP.— $\frac{1}{8}$  DP.—on a 6.750 B.C.





# 4200PG SERIES - Parallel Gear Spindles



Photo #3604

Parallel Geared Spindles have the same high quality and design of the other spindles described in this catalog except they include a parallel gear set for heavy duty boring and milling at relatively low speeds and high torque.

The helical gear reductions are normally in ratios of three to one, with other ratios available up to five to one, together with the input pulley are varied to produce the exact output speed required with use of standard motors.

The precision Timken bearings are normally grease packed. The helical gears and gear case bearings are normally splash lubricated. Recirculating oil lubrication is available.

The standard spindle nose is flanged for piloted-bolt-on tooling. Alternate spindle noses are available, reference page 37.

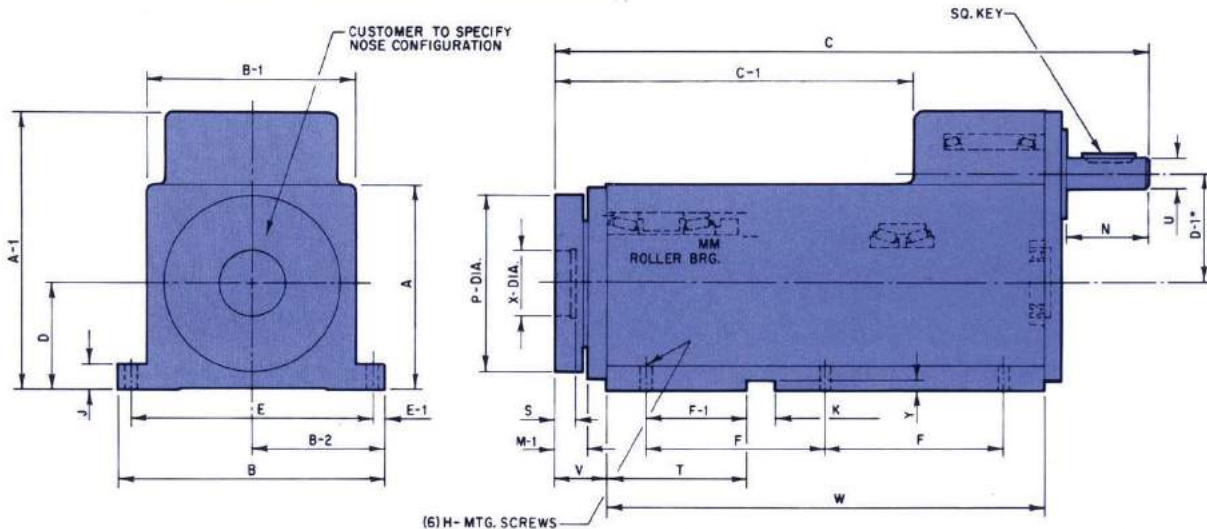

\*D-1 Dimension—Note that Drive Pulley may interfere with Coolant Union, Power Draw Bar, etc....

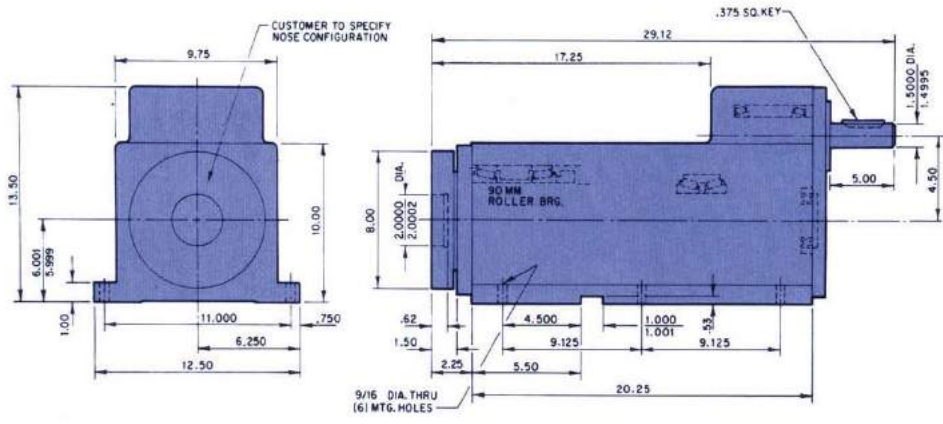

## 4208PG

1. Operating Speed—Grease Lubrication  
Gear Ratio 3:1  
1200 Output RPM Max.
2. Max. Torque Rating—2600 in./lbs.  
1/25 H.P./Rev. [.04]
3. Run-Out Tolerances  
Mounting Face .0003 T.I.R. Max.  
Pilot Dia. .0003 T.I.R. Max.
4. Weight Approx. 550 Lbs.



# - Parallel Gear Spindles

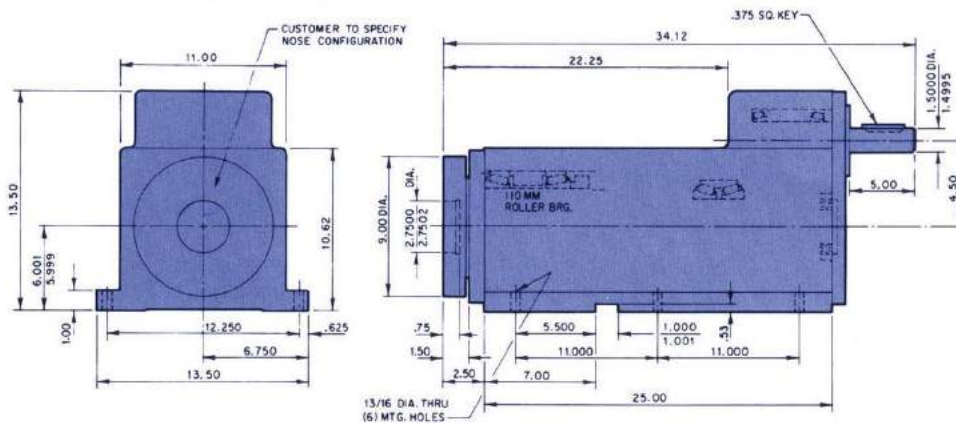

## 4210PG

1. Operating Speed—Grease Lubrication  
Gear Ratio 3:1  
1200 Output RPM Max.
2. Max. Torque Rating—4250 in./lbs.  
1/15 H.P./Rev. [.0666]
3. Run-Out Tolerances  
Mounting Face .0004 T.I.R. Max.  
Pilot Dia. .0004 T.I.R. Max.
4. Weight Approx. 800 Lbs.

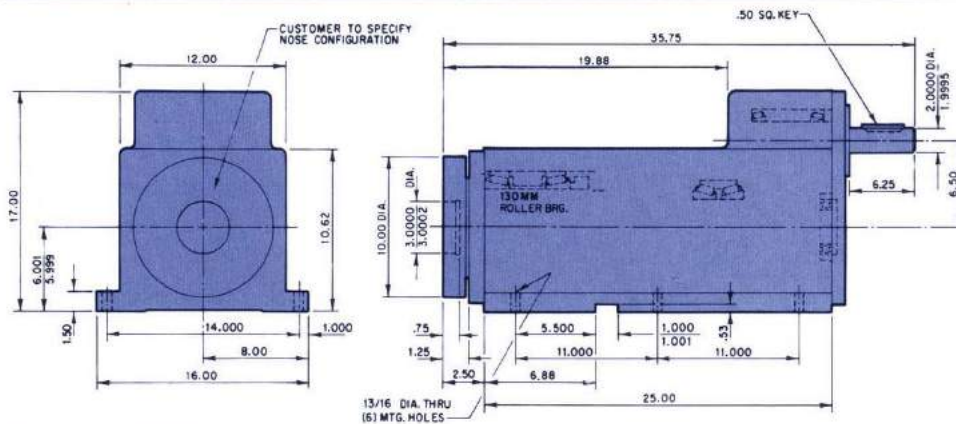

## 4212PG

1. Operating Speed—Grease Lubrication  
Gear Ratio 3:1  
800 Output RPM Max.
2. Max. Torque Rating—7950 in./lbs.  
1/8 H.P./Rev. [.125]
3. Run-Out Tolerances  
Mounting Face .0004 T.I.R. Max.  
Pilot Dia. .0004 T.I.R. Max.
4. Weight Approx. 900 Lbs.

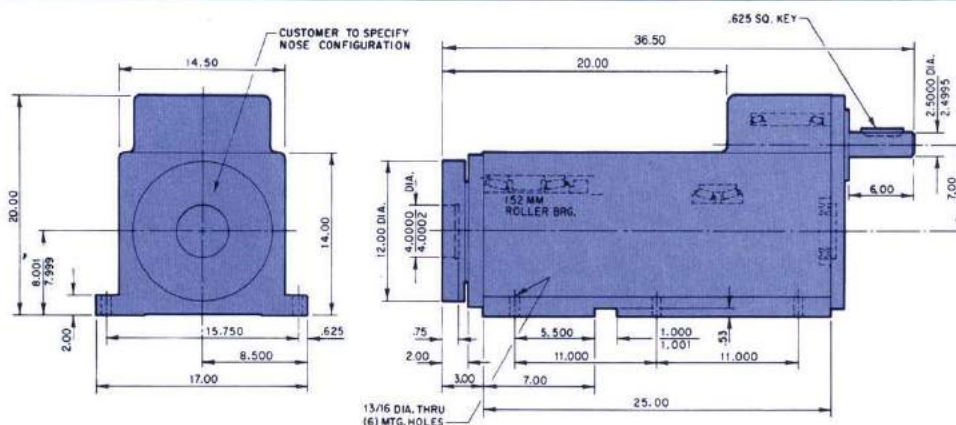

## 4214PG

1. Operating Speed—Grease Lubrication  
Gear Ratio 3:1  
800 Output RPM Max.
2. Max. Torque Rating—15900 in./lbs.  
1/4 H.P./Rev. [.25]
3. Run-Out Tolerances  
Mounting Face .0004 T.I.R. Max.  
Pilot Dia. .0004 T.I.R. Max.
4. Weight Approx. 1400 Lbs.

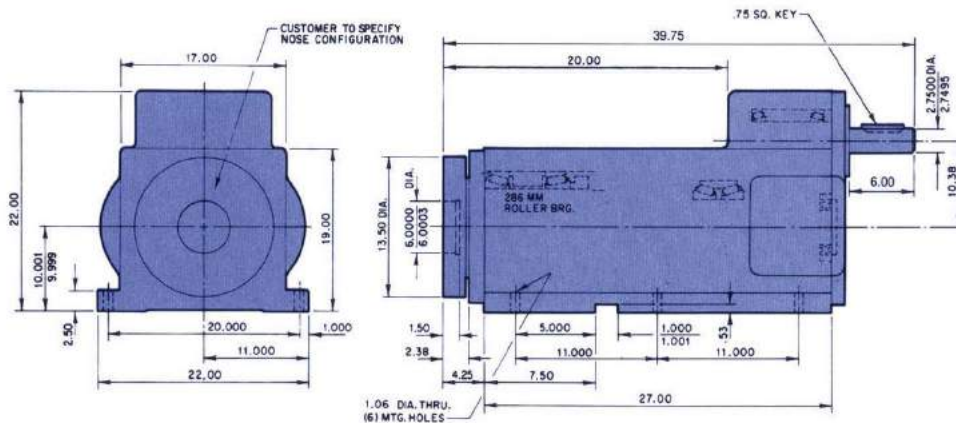

## 4218PG

1. Operating Speed—Grease Lubrication  
Gear Ratio 3:1  
500 Output RPM Max.
2. Max. Torque Rating—44500 in./lbs.  
5/7 H.P./Rev. [.714]
3. Run-Out Tolerances  
Mounting Face .0004 T.I.R. Max.  
Pilot Dia. .0004 T.I.R. Max.
4. Weight Approx. 2400 Lbs.





# 4200WG SERIES - Worm Gear Spindles



Photo #3409

The "WG" Series Spindles offer the same advantage as the "PG" Series Parallel Gear Spindles on pages 16 and 17 except are available with higher gear reduction ratios.

All "WG" Series Spindles are designed with a "Cone" Drive double enveloping worm gear. The horsepower, gear ratios and operating speeds are specified for each size spindle.

The standard spindle nose is flanged for piloted-bolt-on tooling. Alternate spindle noses are available, reference page 37.

### SERVICE FACTORS FOR GEARS

**CLASS 1:** Normal 8-10 hour service free from recurrent shocks (i.e. shock loads that recur at approximately even and frequent intervals). Horsepower ratings taken from the charts are to be applied directly in this classification.

**CLASS 2:** 8-10 hour service where recurrent shock loading is encountered, or 24-hour service where no shock loading is experienced. Class 1 rating must be reduced by dividing by 1.2 for this service.

**CLASS 3:** 24-hour shock load service. Class 1 rating must be reduced by dividing by 1.3 for this service.

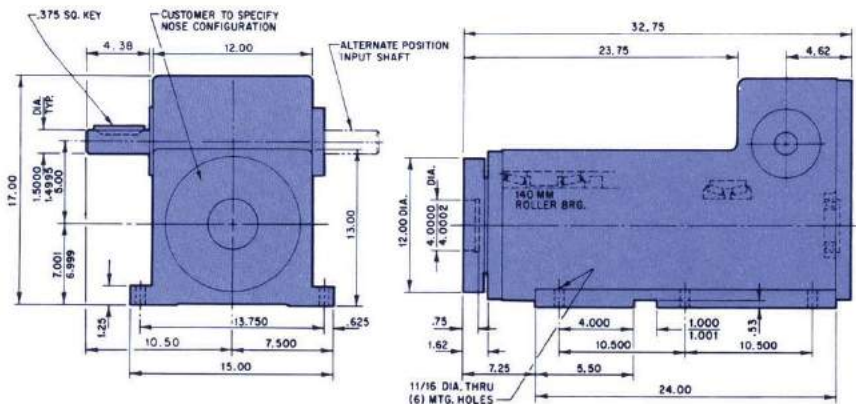
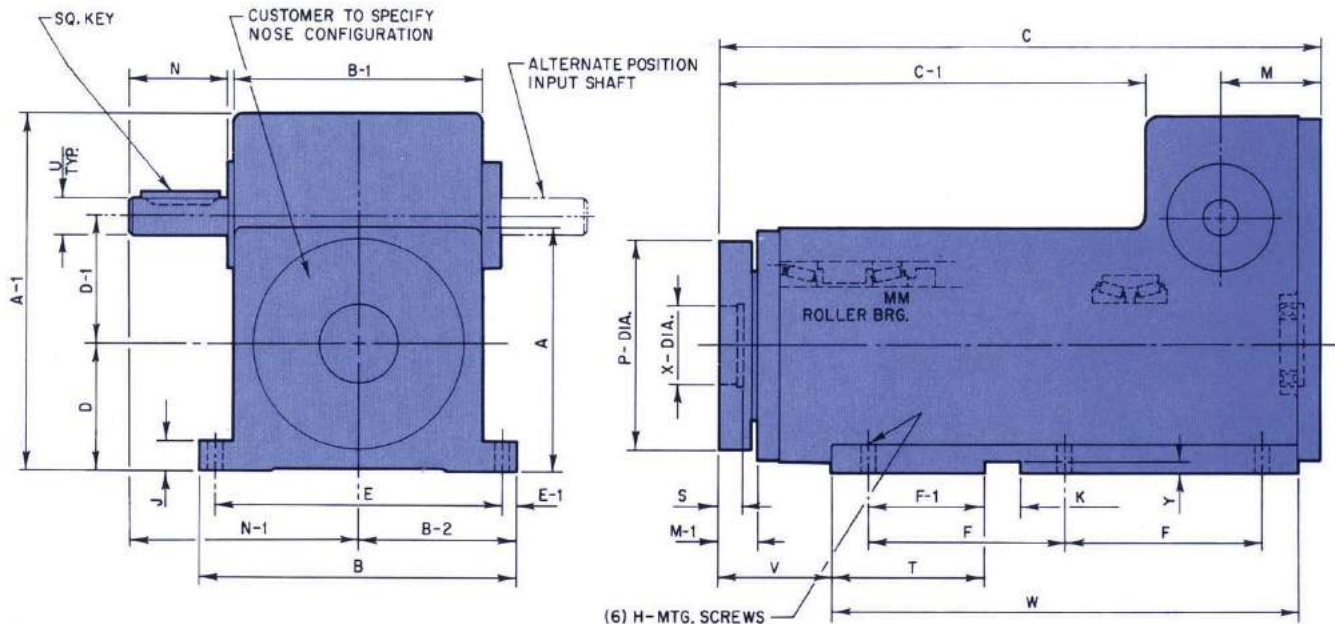

## 4213WG

- Horse Power—RPM Rating—Class One

Output Speeds	100	200	300	600
Ratio	Input/Output H.P. Ratings			
5:1	25.5/	37.6/	45.6/	59.2/
	23.2	34.6	41.9	54.4
10:1	25.1/	34.8/	40.2/	—
	22.6	31.3	36.2	

- Run-Out Tolerances  
Mounting Face .0004 T.I.R. Max.  
Pilot Dia. .0004 T.I.R. Max.
- Weight Approx. 1400 Lbs.



# - Worm Gear Spindles

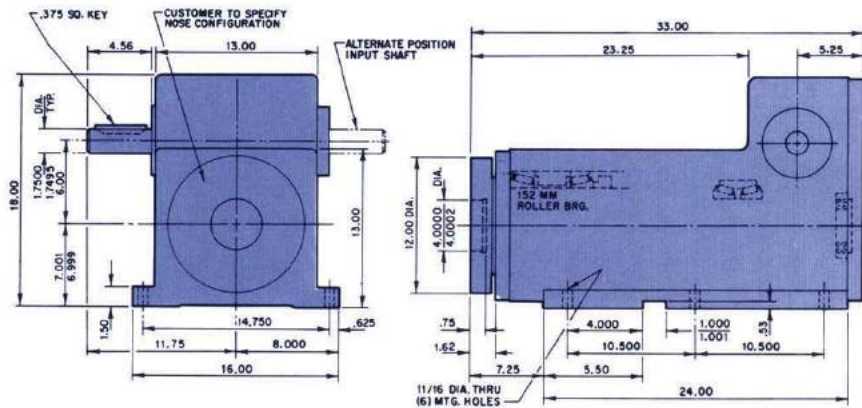

## 4214WG

- Horse Power—RPM Rating—Class One
 

Output Speeds	100	175	250	450
Ratio	Input/Output H.P. Ratings			
5:1	35.9/32.7	49.2/45.2	56.8/52.3	73.2/67.4
10:1	36.0/32.0	46.6/41.9	52.7/47.4	—
- Run-Out Tolerances
 

Mounting Face	.0004 T.I.R. Max.
Pilot Dia.	.0004 T.I.R. Max.
- Weight Approx. 1600 Lbs.

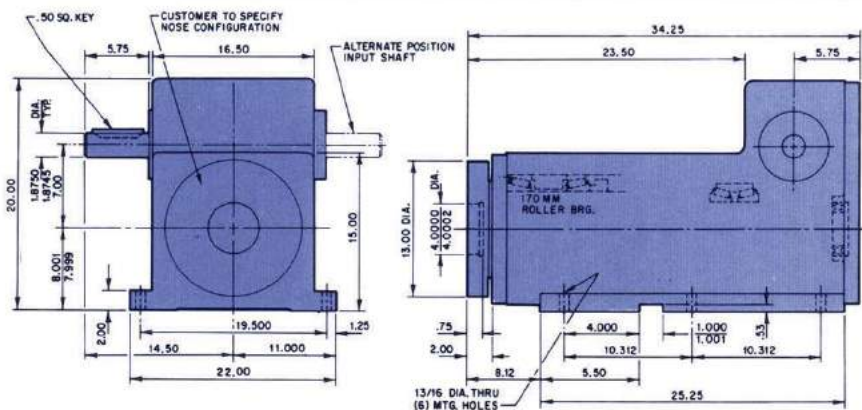

## 4215WG

- Horse Power—RPM Rating—Class One
 

Output Speeds	100	150	230	380
Ratio	Input/Output H.P. Ratings			
5:1	54.8/49.8	68.6/62.4	83.5/76.8	99.0/91.1
10:1	54.6/48.6	64.4/57.9	75.9/68.3	—
- Run-Out Tolerances
 

Mounting Face	.0004 T.I.R. Max.
Pilot Dia.	.0004 T.I.R. Max.
- Weight Approx. 2300 Lbs.

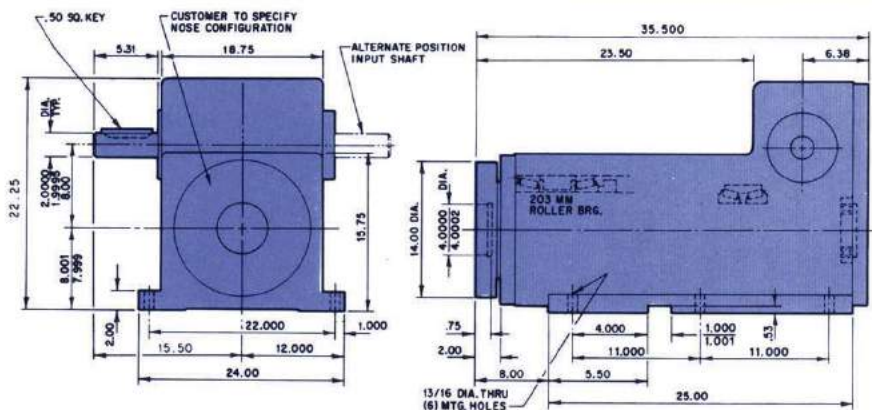

## 4216WG

- Horse Power—RPM Rating—Class One
 

Output Speeds	50	125	200	330
Ratio	Input/Output H.P. Ratings			
5:1	52.5/47.3	88.4/80.4	109.9/101.1	131.7/121.2
10:1	53.6/46.1	87.4/78.6	103.9/93.5	—
- Run-Out Tolerances
 

Mounting Face	.0004 T.I.R. Max.
Pilot Dia.	.0004 T.I.R. Max.
- Weight Approx. 2700 Lbs.

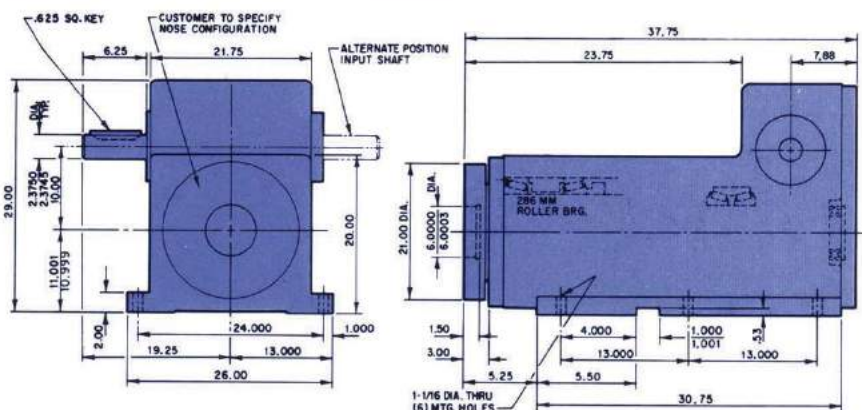

## 4218WG

- Horse Power—RPM Rating—Class One
 

Output Speeds	50	100	150	280
Ratio	Input/Output H.P. Ratings			
5:1	93.4/85.9	135.7/126.2	166.7/155.0	207.2/194.8
10:1	96.1/84.6	136.3/124.0	157.8/145.2	—
- Run-Out Tolerances
 

Mounting Face	.0004 T.I.R. Max.
Pilot Dia.	.0004 T.I.R. Max.
- Weight Approx. 4400 Lbs.





# 4300M SERIES - Milling Spindles



Photo #3872

The SETCO 4300M Series of Super Precision Milling Spindles have the same high quality standards as the 4300B Series Boring Spindles shown on page 8. These spindles include a triplex set (except size 4302M) of select fit bearings which are ideal for axial and radial thrust loads experienced during heavy duty metal removal with milling cutters.

These spindles are available in smaller and larger sizes than stated below, consult factory for exact specifications. Optional nose designs are illustrated on page 37. Reference pages 6 and 7 for the standard features and lettered dimensions. Spindles can be modified to meet with your exact requirements.

The Bearing Sizes shown on each 4300M Series Milling Spindle reflect the exact O.D. shaft size.

## 4302M

1. Operating Speed—Grease Lubrication  
3000 RPM Max. With Rubbing Seals  
10800 RPM Max. With Labyrinth Seals  
18000 RPM Max. With Oil Mist Lubrication
2. Max. Torque Rating—70 in./lbs.  
1/900 H.P./Rev. [.001]
3. Run-Out Tolerances  
Max. Collet  
Bore Run-Out .0005 T.I.R. Max.
4.  $wk^2=7$  lbs. in<sup>2</sup>
5. Weight Approx. 60 lbs.

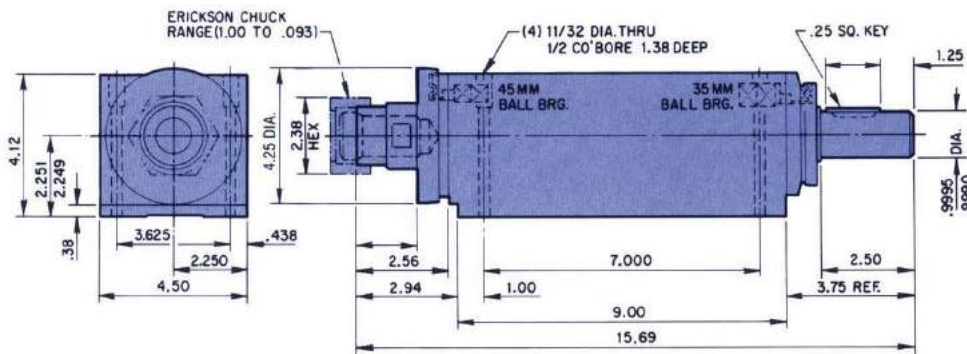

## 4303M

1. Operating Speed—Grease Lubrication  
2800 RPM Max. With Rubbing Seals  
9900 RPM Max. With Labyrinth Seals  
16500 RPM Max. With Oil Mist Lubrication
2. Max. Torque Rating—175 in./lbs.  
1/350 H.P./Rev. [.0028]
3. Run-Out Tolerances  
Axial Face .0002 T.I.R. Max.  
Radial Face .0002 T.I.R. Max.  
Int. Taper .0001 T.I.R. Max.
4.  $wk^2=9$  lbs. in<sup>2</sup>
5. Weight Approx. 80 lbs.

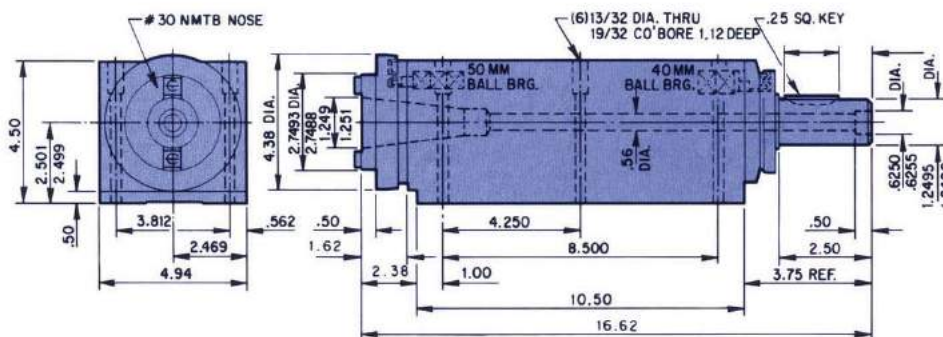

## 4304M

1. Operating Speed—Grease Lubrication  
2200 RPM Max. With Rubbing Seals  
8300 RPM Max. With Labyrinth Seals  
14000 RPM Max. With Oil Mist Lubrication
2. Max. Torque Rating—500 in./lbs.  
1/125 H.P./Rev. [.008]
3. Run-Out Tolerances  
Axial Face .0002 T.I.R. Max.  
Radial Face .0002 T.I.R. Max.  
Int. Taper .0001 T.I.R. Max.
4.  $wk^2=18$  lbs. in<sup>2</sup>
5. Weight Approx. 125 lbs.

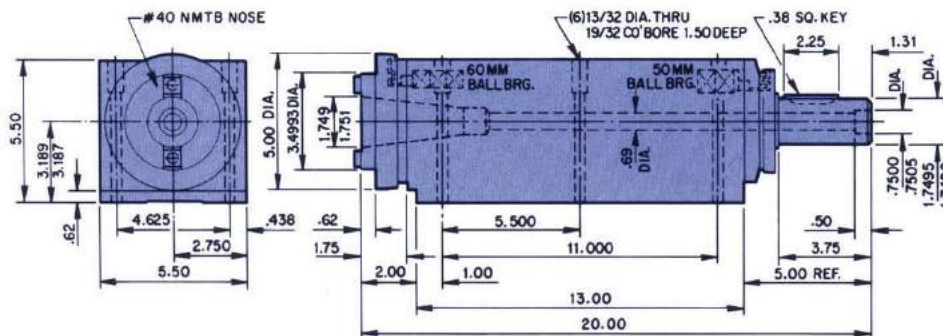



# - Milling Spindles

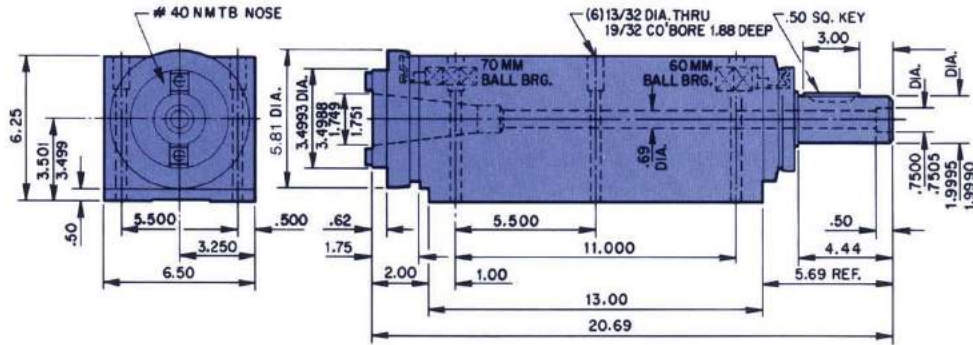

## 4305M

- Operating Speed—Grease Lubrication  
2000 RPM Max. With Rubbing Seals  
7100 RPM Max. With Labyrinth Seals  
12000 RPM Max. With Oil Mist Lubrication
- Max. Torque Rating—950 in./lbs.  
1/60 H.P./Rev. [.0166]
- Run-Out Tolerances  
Axial Face .0002 T.I.R. Max.  
Radial Face .0002 T.I.R. Max.  
Int. Taper .0001 T.I.R. Max.
- $wk^2=32$  lbs. in<sup>2</sup>
- Weight Approx. 175 lbs.

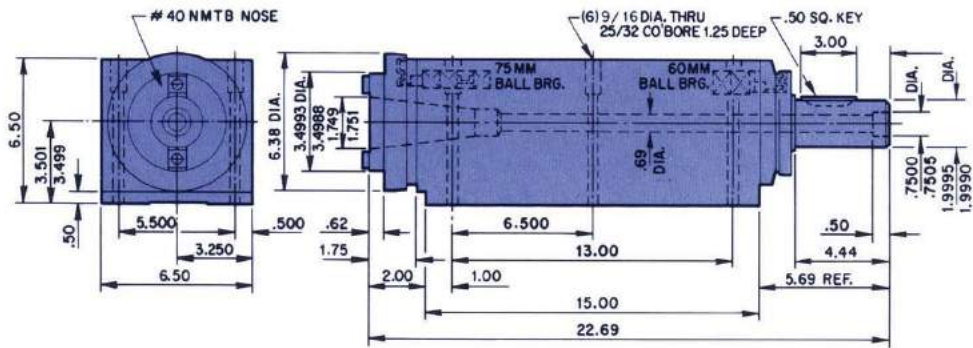

## 4306M

- Operating Speed—Grease Lubrication  
1900 RPM Max. With Rubbing Seals  
6700 RPM Max. With Labyrinth Seals  
11000 RPM Max. With Oil Mist Lubrication
- Max. Torque Rating—1275 in./lbs.  
1/50 H.P./Rev. [.02]
- Run-Out Tolerances  
Axial Face .0003 T.I.R. Max.  
Radial Face .0003 T.I.R. Max.  
Int. Taper .0002 T.I.R. Max.
- $wk^2=44$  lbs. in<sup>2</sup>
- Weight Approx. 200 lbs.

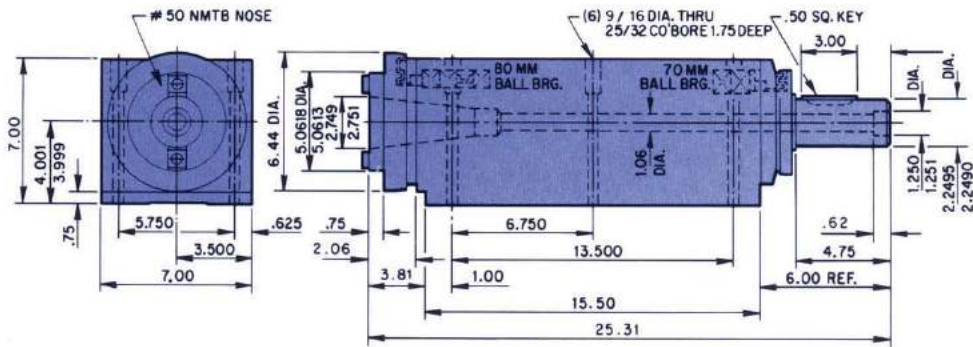

## 4307M

- Operating Speed—Grease Lubrication  
1700 RPM Max. With Rubbing Seals  
6200 RPM Max. With Labyrinth Seals  
10500 RPM Max. With Oil Mist Lubrication
- Max. Torque Rating—1700 in./lbs.  
1/40 H.P./Rev. [.025]
- Run-Out Tolerances  
Axial Face .0003 T.I.R. Max.  
Radial Face .0003 T.I.R. Max.  
Int. Taper .0002 T.I.R. Max.
- $wk^2=55$  lbs. in<sup>2</sup>
- Weight Approx. 250 lbs.

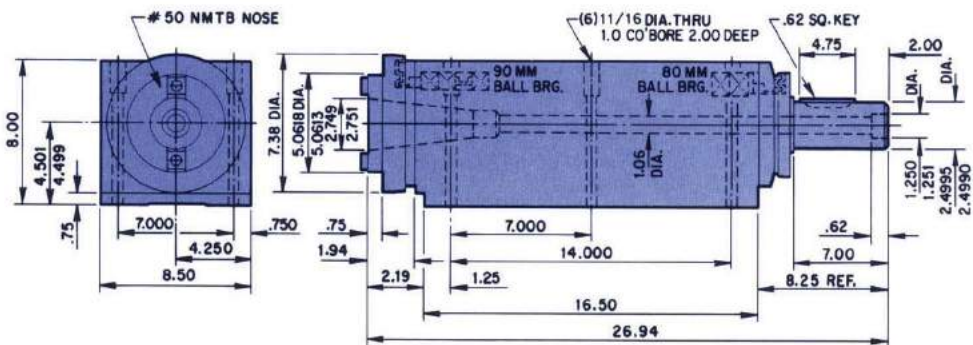

## 4308M

- Operating Speed—Grease Lubrication  
1500 RPM Max. With Rubbing Seals  
5500 RPM Max. With Labyrinth Seals  
9400 RPM Max. With Oil Mist Lubrication
- Max. Torque Rating—2600 in./lbs.  
1/25 H.P./Rev. [.04]
- Run-Out Tolerances  
Axial Face .0003 T.I.R. Max.  
Radial Face .0003 T.I.R. Max.  
Int. Taper .0002 T.I.R. Max.
- $wk^2=149$  lbs. in<sup>2</sup>
- Weight Approx. 350 lbs.





# RM SERIES- Worm Gear Milling Spindles



Photo #3539

**Compact Low Speed Spindles.** These spindles offer the same quality and precision design as the other spindles throughout the catalog but they also provide high torque and low speeds in a very **compact package**.

Spindles are available in either 5:1 or 10:1 worm gear ratios. All types incorporate "Cone" Drive enveloping worm reduction gear sets which provide a maximum torque carrying capacity in a minimum spindle housing. Spindles are designed for input shafts on either side, Timken Roller Bearings, standard NMTBA noses and can be provided with motor adjusting plates.

The selection chart below illustrates the maximum input and output speeds at maximum horsepowers. Select the proper size spindle based on your known horsepower and speed requirements.

#### SERVICE FACTORS FOR GEARS

**CLASS 1:** Normal 8-10 hour service free from recurrent shocks (i.e. shock loads that recur at approximately even and frequent intervals). Horsepower ratings taken from the charts are to be applied directly in this classification.

**CLASS 2:** 8-10 hour service where recurrent shock loading is encountered, or 24-hour service where no shock loading is experienced. Class 1 rating must be reduced by dividing by 1.2 for this service.

**CLASS 3:** 24-hour shock load service. Class 1 rating must be reduced by dividing by 1.3 for this service.

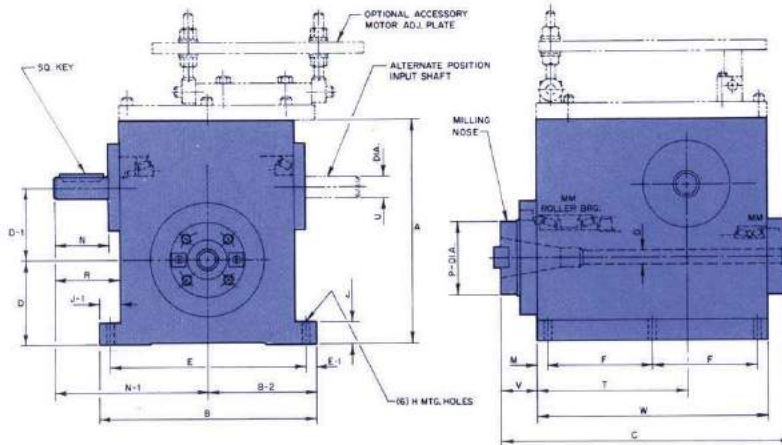

#### INPUT MECHANICAL HORSEPOWER RATINGS CLASS 1

RM 2-5				RM 5-5				RM 5-10				RM 10-5				RM 10-10			
MAX. OUTPUT RPM-875				MAX. OUTPUT RPM-650				MAX. OUTPUT RPM-390				MAX. OUTPUT RPM-615				MAX. OUTPUT RPM-315			
SPEED OUTPUT	MAX HP OUTPUT	MAX HP INPUT	SPEED INPUT	SPEED OUTPUT	MAX HP OUTPUT	MAX HP INPUT	SPEED INPUT	SPEED OUTPUT	MAX HP OUTPUT	MAX HP INPUT	SPEED INPUT	SPEED OUTPUT	MAX HP OUTPUT	MAX HP INPUT	SPEED INPUT	SPEED OUTPUT	MAX HP OUTPUT	MAX HP INPUT	SPEED INPUT
20	1.14	1.31	100	20	3.22	3.62	100	10	1.93	2.32	100	20	6.36	7.15	100	10	3.84	4.63	100
40	1.78	2.51	200	40	6.14	6.82	200	20	3.63	4.27	200	40	11.92	13.26	200	20	7.20	8.47	200
60	3.20	3.60	300	60	8.46	9.30	300	30	5.17	6.02	300	60	16.74	18.40	300	30	10.21	11.87	300
116	5.38	6.04	580	116	13.51	14.85	580	58	8.66	9.95	580	116	25.75	28.30	580	58	16.37	18.82	580
144	6.20	6.97	720	144	15.24	16.75	720	72	10.13	11.38	720	144	28.80	31.65	720	72	18.81	21.13	720
174	7.08	7.87	870	174	17.02	18.50	870	87	11.25	12.65	870	174	32.34	35.15	870	87	20.83	23.40	870
230	8.12	9.02	1150	230	20.05	21.80	1150	115	13.36	14.85	1150	230	37.26	40.50	1150	115	24.45	27.17	1150
350	10.17	11.30	1750	350	24.52	26.65	1750	175	16.56	18.40	1750	350	46.25	49.20	1750	175	30.10	33.45	1750
480	11.70	13.00	2400	480	27.32	29.70	2400	240	19.00	21.10	2400	480	50.05	54.40	2400	240	33.30	37.00	2400

1) Above R.P.M./H.P. Ratings Are With Oil Splash Lubrication  
 2) For Other R.P.M. Than Shown Contact Factory



# - Worm Gear Milling Spindles

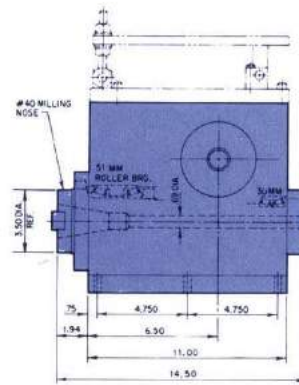
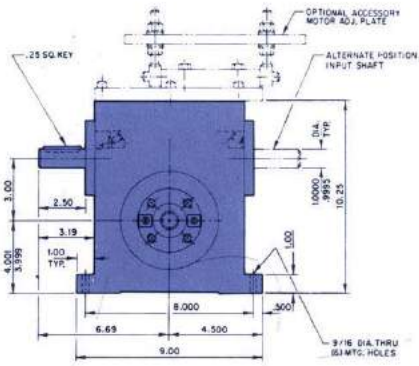

## RM2-5 RM2-10

- Run-Out Tolerances
  - Axial Face .0002 T.I.R. Max.
  - Radial Face .0002 T.I.R. Max.
  - Int. Taper .0002 T.I.R. Max.
- Weight Approx. 200 lbs.

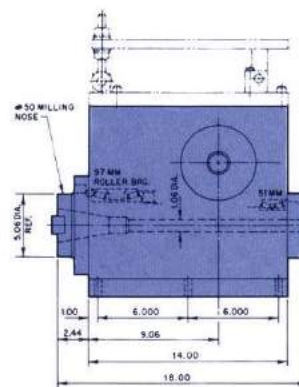
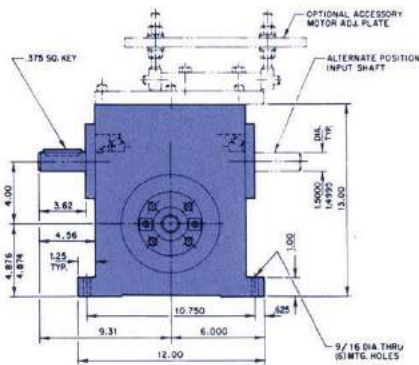

## RM5-5 RM5-10

- Run-Out Tolerances
  - Axial Face .0003 T.I.R. Max.
  - Radial Face .0003 T.I.R. Max.
  - Int. Taper .0003 T.I.R. Max.
- Weight Approx. 385 lbs.

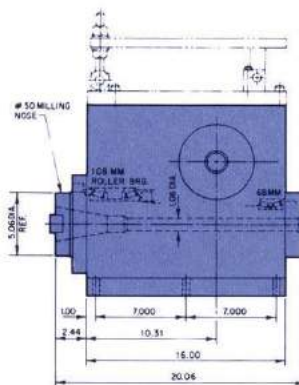
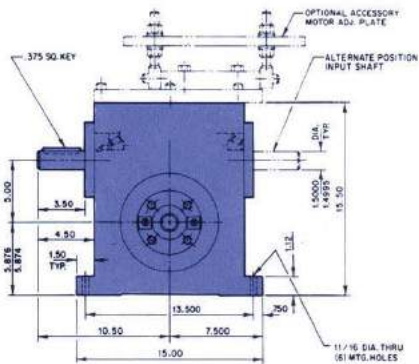

## RM10-5 RM10-10

- Run-Out Tolerances
  - Axial Face .0004 T.I.R. Max.
  - Radial Face .0004 T.I.R. Max.
  - Int. Taper .0004 T.I.R. Max.
- Weight Approx. 550 lbs.



Photo #4096



Photo #3831



Photo # 3637





# 'RA' SERIES - Right Angle Milling Attachments



Photo #3939

## \*SERVICE FACTORS FOR GEARS

**CLASS 1:** Normal 8-10 hour service free from recurrent shocks (i.e. shock loads that recur at approximately even and frequent intervals). Horsepower ratings taken from the charts are to be applied directly in this classification.

**CLASS 2:** 8-10 hour service where recurrent shock loading is encountered, or 24-hour service where no shock loading is experienced. Class 1 rating must be reduced by dividing by 1.25 for this service.

**CLASS 3:** 24-hour shock load service. Class 1 rating must be reduced by dividing by 1.75 for this service.

The SETCO 'RA' Series of Super Precision Right Angle Milling Attachments have the same high quality standards as the other spindles illustrated in this catalog. These Right Angle Attachments include: standard 1:1 gear ratio (special ratios are available), coupling adapter, coupling, intermediate flange (Ref. Dimensions 'B', 'B-1' & 'J') to customers specifications and the standard features as illustrated on page 6. The overall length of the Right Angle Attachment (Dimensions 'A' and 'D') is available to suit the customers exact requirements. The design illustrated in the lettered dimension drawing below has a self-contained driving shaft requiring a coupling adapter to the machine tool or spindle by means of a draw bar or bolt-on face adapter. An alternate design as shown in Photo #2933, page 25, close couples the attachment for minimum overhang. In this design, a driving gear is mounted on the nose of the machine tool spindle to mate with a driven gear inside the attachment.

The Right Angle Attachments are available with an optional "shot-pin" mounting flange arrangement for positioning and locking in any 90° location (Ref. Photo #3936, page 25). These attachments are designed to convert standard milling spindles to dual purpose and are available to retrofit a wide range of machine tools. They have been adapted to horizontal and vertical machining centers, jig mills and planer millers. These attachments make a difficult machining job easier. Optional nose designs are illustrated on page 37.

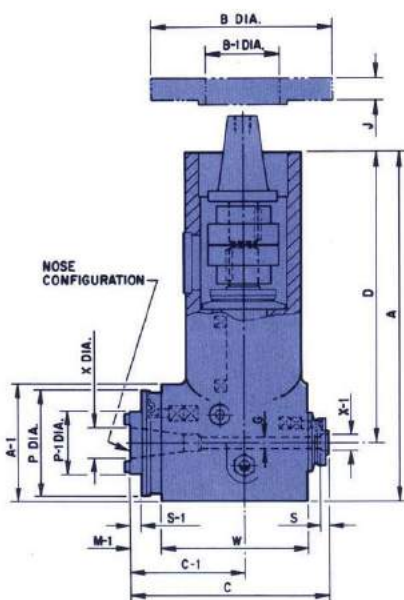

TYPE	1RA	2RA	3RA	4RA	5RA	6RA	7RA	8RA
Max. R.P.M.	3000	2500	2100	1700	1500	1300	1200	950
NMTBA Nose	#30	#40	#50	#50	#50	#50	#50	#50
HORSEPOWER/ 100 R.P.M. CLASS 1 RANGE*	2.01	3.11	4.82	8.5	12.6	18.7	23.0	40.2
	0-1250	0-1090	0-954	0-763	0-636	0-545	0-477	0-382
	1.84	2.86	4.43	7.82	11.59	17.2	21.2	36.98
EFFECTIVE SPEED RATING R.P.M.	1250-1900	1090-1635	954-1430	763-1145	636-954	545-818	477-716	382-572
	1.75	2.71	4.19	7.40	10.96	16.27	20.0	34.97
	1900-2550	1635-2180	1430-1908	1145-1526	954-1272	818-1090	716-954	572-763
Run-out Tolerances	1.67	2.58	4.0	7.06	10.46	15.52	19.09	33.4
	2550-3000	2180-2500	1908-2100	1526-1700	1272-1500	1090-1300	954-1200	763-950
	T.I.R. MAX.	T.I.R. MAX.	T.I.R. MAX.	T.I.R. MAX.	T.I.R. MAX.	T.I.R. MAX.	T.I.R. MAX.	T.I.R. MAX.
Axial Face	.0002	.0002	.0003	.0003	.0003	.0003	.0003	.0003
Radial Face	.0002	.0002	.0003	.0003	.0003	.0003	.0003	.0003
Internal Taper	.0001	.0001	.0002	.0002	.0002	.0002	.0002	.0002
Ball Bearing Bore Size Front/Rear	50mm 40mm	60mm 50mm	80mm 70mm	90mm 80mm	100mm 85mm	110mm 95mm	120mm 100mm	130mm 110mm
Approx. Wts.	90 lbs.	175 lbs.	350 lbs.	450 lbs.	600 lbs.	800 lbs.	1000 lbs.	1600 lbs.
A	14.50	19.25	22.00	22.50	23.00	25.50	26.00	27.50
A-1	5.0	6.5	8.0	9.0	10.0	11.0	12.0	15.0
B	CUSTOMER TO SPECIFY							
B-1	CUSTOMER TO SPECIFY							
C	8.88	10.81	14.88	16.75	18.50	20.25	21.50	24.25
C-1	5.44	6.00	9.25	10.50	11.75	13.00	13.75	15.0
D	12.0	16.0	18.0	18.0	18.0	20.0	20.0	20.0
G	.56	.69	1.06	1.06	1.06	1.06	1.06	1.06
M-1	1.56	1.75	1.94	1.94	2.12	2.12	2.12	2.12
P	5.00	5.00	6.38	7.38	7.88	8.75	9.38	10.12
P-1	2.75	3.50	5.06	5.06	5.06	5.06	5.06	5.06
S	.53	.50	.62	.62	.62	.62	.62	.62
S-1	.50	.62	.75	.75	.75	.75	.75	.75
W	6.62	7.88	11.69	13.44	15.00	16.75	18.00	20.75
X	1.250	1.750	2.750	2.750	2.750	2.750	2.750	2.750
X-1	.781	.750	1.250	1.250	1.250	1.250	1.250	1.250

\*Actual cutting horsepower could vary dependant on application.



# -RIGHT ANGLE MILLING ATTACHMENTS

The Special Right Angle Attachments and extended adapters as illustrated in the lettered dimensional drawings below are designed to the customer's exact specifications. These attachments offer additional versatility to Flexible Machining Systems normally

consisting of horizontal and vertical machining centers. The attachments are primarily intended for milling operations in confined spaces. However, a variety of these units have been adapted to boring and drilling operations.

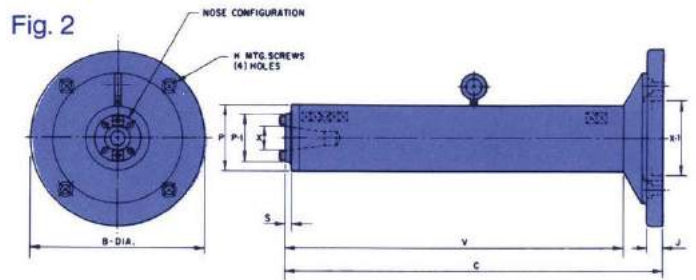
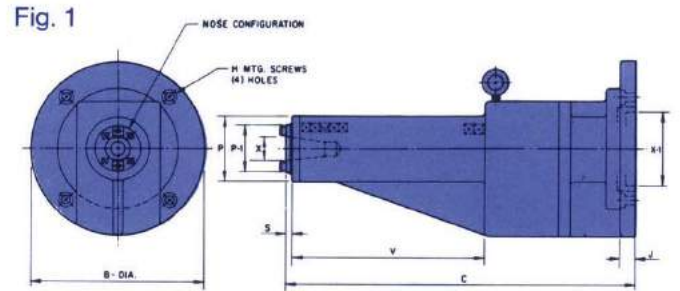





# Alternate Spindle Housings - Boring & Milling

There are four alternate spindle housing designs for both the Milling and Boring Belt Driven Spindles. The 4000 Series "Cartridge Style" and 4100 Series "Flanged Cartridge Style" are normally designed to customer's exact requirements.

Both the 4200 Series "Foot Mounted Design" and 4400 Series "I" Type Design have slightly different mounting dimensions from the standard 4300B Series shown on pages

8-11 and 4300M Series shown on pages 20 and 21. All other dimensions not shown would be identical to the corresponding 4300 Series.

Optional nose designs are illustrated on page 37. Reference pages 6 and 7 for the standard features offered with each spindle design.

## 4000M/4100M SERIES Cartridge and Flanged Cartridge Design

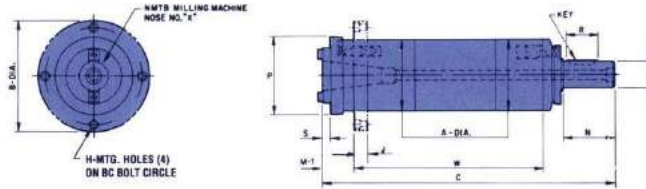

TYPE	A	B	C	H	J	KEY	M-1	N	P	R	S	U	W	X	BC
40/4102M	3.7490 3.7485	4.75	15.69	1 1/32	.62	.25 sq.	2.56	2.50	4.25	.94	1.62	.9995 .9990	9.38	—	4.875
40/4103M	3.9990 3.9985	5.88	16.62	1 3/32	.62	.25 sq.	1.62	2.50	4.38	.94	.50	1.2495 1.2490	11.25	#30	5.125
40/4104M	4.6240 4.6235	6.50	20.00	1 3/32	.62	.38 sq.	1.75	3.75	5.00	2.25	.62	1.7495 1.7490	13.25	#40	5.688
40/4105M	5.4990 5.4985	7.25	20.69	1 3/32	.75	.50 sq.	1.75	4.44	5.81	3.00	.62	1.9995 1.9990	13.25	#40	6.375
40/4106M	5.9990 5.9985	8.25	22.69	9/16	.75	.50 sq.	1.75	4.44	6.38	3.00	.62	1.9995 1.9990	15.25	#40	7.188
40/4107M	5.9990 5.9985	8.25	25.31	9/16	.75	.50 sq.	2.06	4.75	6.44	3.00	.75	2.2495 2.2490	17.25	#50	7.250
40/4108M	6.9990 6.9985	9.25	26.94	9/16	1.00	.62 sq.	1.94	7.00	7.38	4.75	.75	2.4995 2.4990	16.75	#50	8.000

## 4200M SERIES Foot Mount Design

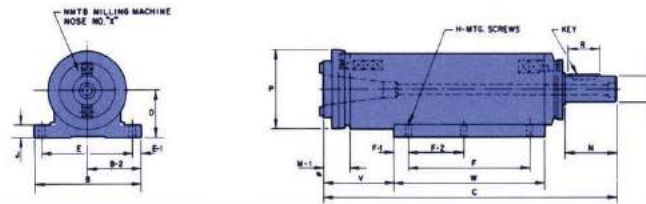

TYPE	B	B-2	C	D	E	E-1	F	F-1	F-2	H	J	KEY	M-1	N	P	R	U	V	W	X
4202M	7.00	3.50	15.69	2.251 2.249	5.750	.625	7.000	1.00	—	1 1/32	.75	.25 sq.	2.56	2.50	4.25	1.00	.9995 .9990	2.94	9.00	—
4203M	8.00	4.00	16.62	2.501 2.499	6.500	.750	8.500	1.00	4.250	1 3/32	.75	.25 sq.	1.62	2.50	4.38	1.00	1.2495 1.2490	2.38	10.50	#30
4204M	8.50	4.25	20.00	3.189 3.187	7.000	.750	11.000	1.00	5.500	1 3/32	1.00	.38 sq.	1.75	3.75	5.00	2.25	1.7495 1.7490	2.00	13.00	#40
4205M	8.50	4.25	20.69	3.501 3.499	7.500	.500	11.000	1.00	5.500	1 3/32	1.00	.50 sq.	1.75	4.44	5.81	3.00	1.9995 1.9990	2.00	13.00	#40
4206M	8.50	4.25	22.69	3.501 3.499	7.500	.500	13.000	1.00	6.500	9/16	1.00	.50 sq.	1.75	4.44	6.38	3.00	1.9995 1.9990	2.00	15.00	#40
4207M	9.00	4.50	25.31	4.001 3.999	7.500	.750	13.500	1.00	6.750	9/16	.88	.50 sq.	2.06	4.75	6.44	3.00	2.2495 2.2490	3.81	15.50	#50
4208M	12.00	6.00	26.94	4.501 4.499	10.000	1.000	14.000	1.25	7.000	1 1/16	1.12	.62 sq.	1.94	7.00	7.38	4.75	2.4995 2.4990	2.19	16.50	#50

## 4400M SERIES "I" Type Design

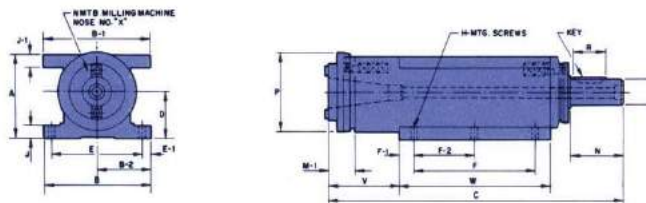

TYPE	A	B	B-1	B-2	C	D	E	E-1	F	F-1	F-2	H	J	J-1	KEY	M-1	N	P	R	U	V	W	X
4402M	4.12	7.00	9.50	3.50	15.69	2.251 2.249	5.750	.625	7.000	1.00	—	1 1/32	.75	.75	.25 sq.	2.56	2.50	4.25	1.00	.9995 .9990	2.94	9.00	—
4403M	4.50	8.00	10.00	4.00	16.62	2.501 2.499	6.500	.750	8.500	1.00	4.250	1 3/32	.75	.75	.25 sq.	1.62	2.50	4.38	1.00	1.2495 1.2490	2.38	10.50	#30
4404M	5.50	8.50	11.00	4.25	20.00	3.189 3.187	7.000	.750	11.000	1.00	5.500	1 3/32	1.00	1.00	.38 sq.	1.75	3.75	5.00	2.25	1.7495 1.7490	2.00	13.00	#40
4405M	6.25	8.50	11.00	4.25	20.69	3.501 3.499	7.500	.500	11.000	1.00	5.500	1 3/32	1.00	1.00	.50 sq.	1.75	4.44	5.81	3.00	1.9995 1.9990	2.00	13.00	#40
4406M	6.50	8.50	11.00	4.25	22.69	3.501 3.499	7.500	.500	13.000	1.00	6.500	9/16	1.00	1.25	.50 sq.	1.75	4.44	6.38	3.00	1.9995 1.9990	2.00	15.00	#40
4407M	7.00	9.00	12.00	4.50	25.31	4.001 3.999	7.500	.750	13.500	1.00	6.750	9/16	1.00	1.00	.50 sq.	2.06	4.75	6.44	3.00	2.2495 2.2490	3.81	15.50	#50
4408M	8.00	12.00	14.00	6.00	26.94	4.501 4.499	10.000	1.000	14.000	1.25	7.000	1 1/16	1.12	1.25	.62 sq.	1.94	7.00	7.38	4.75	2.4995 2.4990	2.19	16.50	#50



# -Boring and Milling

## 400B/410B SERIES Cartridge and Flanged Cartridge Design

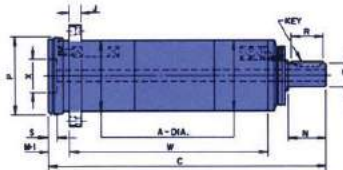
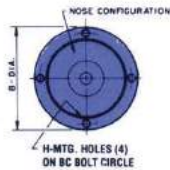

TYPE	A	B	C	H	J	KEY	M-1	N	P	R	S	U	W	X	BC
40/4101B	3.2490 3.2485	5.00	13.25	11/32	.62	.25 sq.	1.62	1.75	3.75	1.50	.75	.9995 .9990	8.62	1.0000 1.0002	4.250
40/4102B	3.7490 3.7485	5.50	14.00	11/32	.62	.25 sq.	1.62	1.75	4.25	1.50	.75	.9995 .9990	9.38	1.0000 1.0002	4.875
40/4103B	3.9990 3.9985	5.88	16.50	13/32	.62	.25 sq.	1.75	2.25	4.44	1.75	.75	1.2495 1.2490	11.25	1.0000 1.0002	5.125
40/4104B	4.6240 4.6235	6.50	19.00	13/32	.62	.38 sq.	1.75	2.75	5.06	2.25	.75	1.4995 1.4990	13.25	1.0000 1.0002	5.688
40/4105B	5.4990 5.4985	7.25	19.00	13/32	.75	.38 sq.	1.75	2.75	5.81	2.25	.75	1.4995 1.4990	13.25	1.0000 1.0002	6.375
40/4106B	5.9990 5.9985	8.25	21.00	9/16	.75	.38 sq.	1.75	2.75	6.31	2.25	.62	1.7495 1.7490	15.25	2.0000 2.0002	7.188
40/4107B	5.9990 5.9985	8.25	23.50	9/16	.75	.50 sq.	1.75	3.25	6.44	2.75	.62	1.9995 1.9990	17.25	2.0000 2.0002	7.250
40/4108B	6.9990 6.9985	9.25	23.50	9/16	1.00	.50 sq.	2.25	3.25	7.38	2.75	.62	2.2495 2.2490	16.75	2.0000 2.0002	8.000
40/4109B	7.9990 7.9985	10.00	28.00	11/16	1.00	.62 sq.	2.38	3.75	10.12	3.00	.62	2.4995 2.4990	20.62	3.0000 3.0002	9.31
40/4110B	8.9990 8.9985	11.50	30.25	11/16	1.50	.62 sq.	2.38	4.00	10.12	3.50	.62	2.4995 2.4990	22.62	3.0000 3.0002	10.31

## 4200B SERIES Foot Mount Design

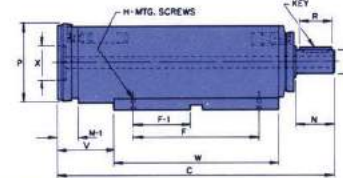
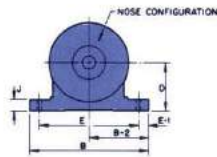

TYPE	B	B-2	C	D	E	E-1	F	F-1	H	J	KEY	M-1	N	P	R	U	V	W	X
4201B	6.50	3.250	13.25	2.001 1.999	5.250	.625	6.000	2.500	11/32	.75	.25 sq.	1.62	1.75	3.75	1.50	.9995 .9990	2.25	8.00	1.0000 1.0002
4202B	7.00	3.500	14.00	2.251 2.249	5.750	.625	6.000	2.500	11/32	.75	.25 sq.	1.62	1.75	4.25	1.50	.9995 .9990	2.50	8.50	1.0000 1.0002
4203B	8.00	4.000	16.50	2.501 2.499	6.500	.750	7.000	3.000	13/32	.75	.25 sq.	1.75	2.25	4.44	1.75	1.2495 1.2490	3.00	10.00	1.0000 1.0002
4204B	8.50	4.250	19.00	3.189 3.187	7.000	.750	9.000	4.000	13/32	1.00	.38 sq.	1.75	2.75	5.06	2.25	1.4995 1.4990	3.00	12.00	1.0000 1.0002
4205B	8.50	4.250	19.00	3.501 3.499	7.500	.500	8.000	3.500	13/32	1.00	.38 sq.	1.75	2.75	5.81	2.25	1.4995 1.4990	4.00	11.00	1.0000 1.0002
4206B	8.50	4.250	21.00	3.501 3.499	7.500	.500	10.000	4.500	9/16	1.00	.38 sq.	1.75	2.75	6.31	2.25	1.7495 1.7490	4.00	13.00	2.0000 2.0002
4207B	9.00	4.500	23.50	4.001 3.999	7.500	.750	11.000	5.000	9/16	.88	.50 sq.	1.75	3.25	6.44	2.75	1.9995 1.9990	5.00	14.00	2.0000 2.0002
4208B	12.00	6.000	23.50	4.501 4.499	10.000	1.000	10.000	4.500	11/16	1.12	.50 sq.	2.25	3.25	7.38	2.75	2.2495 2.2490	6.00	13.00	2.0000 2.0002
*4209B	14.00	7.000	28.00	5.501 5.499	12.000	1.000	13.000	3.000	11/16	1.25	.62 sq.	2.38	3.75	10.12	3.00	2.4995 2.4990	7.00	16.00	3.0000 3.0002
*4210B	14.00	7.000	30.25	5.501 5.499	12.000	1.000	15.000	3.000	11/16	1.50	.62 sq.	2.38	4.00	10.12	3.50	2.4995 2.4990	7.00	18.00	3.0000 3.0002

\*These sizes have 6 mounting holes.

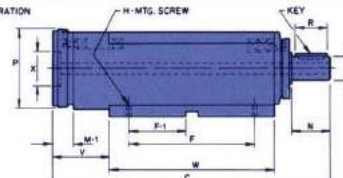
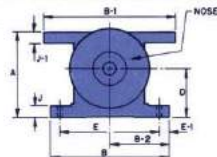

## 4400B SERIES "I" Type Design

TYPE	A	B	B-1	B-2	C	D	E	E-1	F	F-1	H	J	J-1	KEY	M-1	N	P	R	U	V	W	X
4401B	3.62	6.50	9.50	3.250	13.25	2.001 1.999	5.250	.625	6.000	2.500	11/32	.75	.75	.25 sq.	1.62	1.75	3.75	1.50	.9995 .9990	2.25	8.00	1.0000 1.0002
4402B	4.12	7.00	9.50	3.500	14.00	2.251 2.249	5.750	.625	6.000	2.500	11/32	.75	.75	.25 sq.	1.62	1.75	4.25	1.50	.9995 .9990	2.50	8.50	1.0000 1.0002
4403B	4.50	8.00	10.00	4.000	16.50	2.501 2.499	6.500	.750	7.000	3.000	13/32	.75	.75	.25 sq.	1.75	2.25	4.44	1.75	1.2495 1.2490	3.00	10.00	1.0000 1.0002
4404B	5.50	8.50	11.00	4.250	19.00	3.189 3.187	7.000	.750	9.000	4.000	13/32	1.00	1.00	.38 sq.	1.75	2.75	5.06	2.25	1.4995 1.4990	3.00	12.00	1.0000 1.0002
4405B	6.25	8.50	11.00	4.250	19.00	3.501 3.499	7.500	.500	8.000	3.500	13/32	1.00	1.00	.38 sq.	1.75	2.75	5.81	2.25	1.4995 1.4990	4.00	11.00	1.0000 1.0002
4406B	6.50	8.50	11.00	4.250	21.00	3.501 3.499	7.500	.500	10.000	4.500	9/16	1.00	1.25	.38 sq.	1.75	2.75	6.31	2.25	1.7495 1.7490	4.00	13.00	2.0000 2.0002
4407B	7.00	9.00	12.00	4.500	23.50	4.001 3.999	7.500	.750	11.000	5.000	9/16	1.00	1.00	.50 sq.	1.75	3.25	6.44	2.75	1.9995 1.9990	5.00	14.00	2.0000 2.0002
4408B	8.00	12.00	14.00	6.000	23.50	4.501 4.499	10.000	1.000	10.000	4.500	11/16	1.12	1.25	.50 sq.	2.25	3.25	7.38	2.75	2.2495 2.2490	6.00	13.00	2.0000 2.0002
*4409B	9.50	14.00	16.00	7.000	28.00	5.501 5.499	12.000	1.000	13.000	3.000	11/16	1.25	1.25	.62 sq.	2.38	3.75	10.12	3.00	2.4995 2.4990	7.00	16.00	3.0000 3.0002
*4410B	10.00	14.00	18.00	7.000	30.25	5.501 5.499	12.000	1.000	15.000	3.000	11/16	1.50	1.50	.62 sq.	2.38	4.00	10.12	3.50	2.4995 2.4990	7.00	18.00	3.0000 3.0002

\*These sizes have 6 mounting holes.





# COAXIAL 4300XRB SERIES



## CO-AXIAL SPINDLES

Co-axial Spindles are used for boring operations requiring concentricity between two in-line bores, typically as in machining of automotive valve seats and valve stem guide bores and oil pump bodies.

The Co-axial Spindle consists of a spindle arbor with a flange nose arranged to accept bolt-on tooling. This arbor is hollow and fitted with a keyed sliding co-axial arbor provided with a collet chuck (reference Photo "A").

Spindle assembly is furnished with a rotating ball bearing union for adapting linear feed and retract cylinder to the co-ax arbor (reference Photo #4081).

Optionally, co-ax arbor can be provided with a coolant union to present coolant through tooling (reference Photo "B").

Spindle drive is normally a two speed motor for high and low speed requirement.

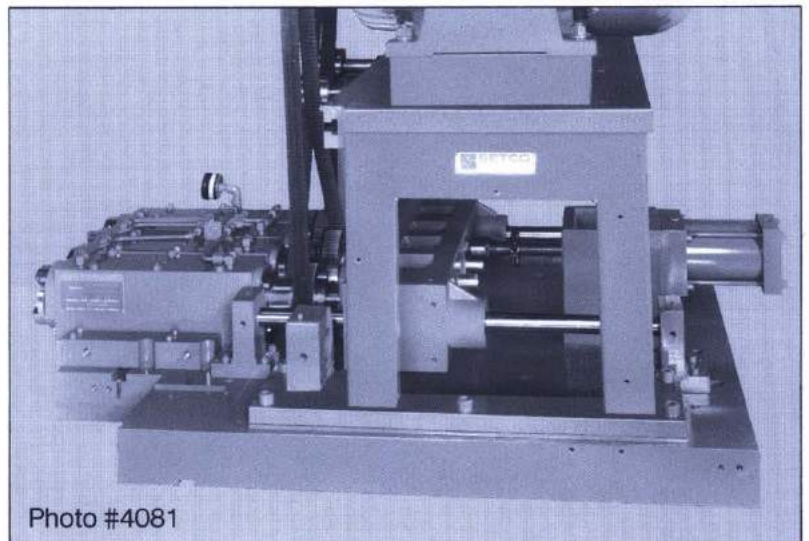
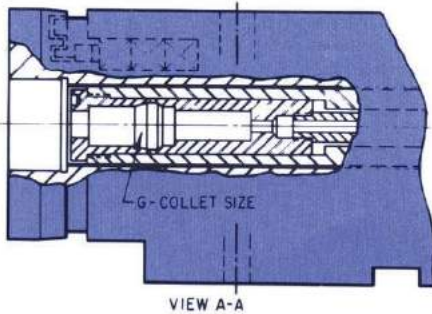
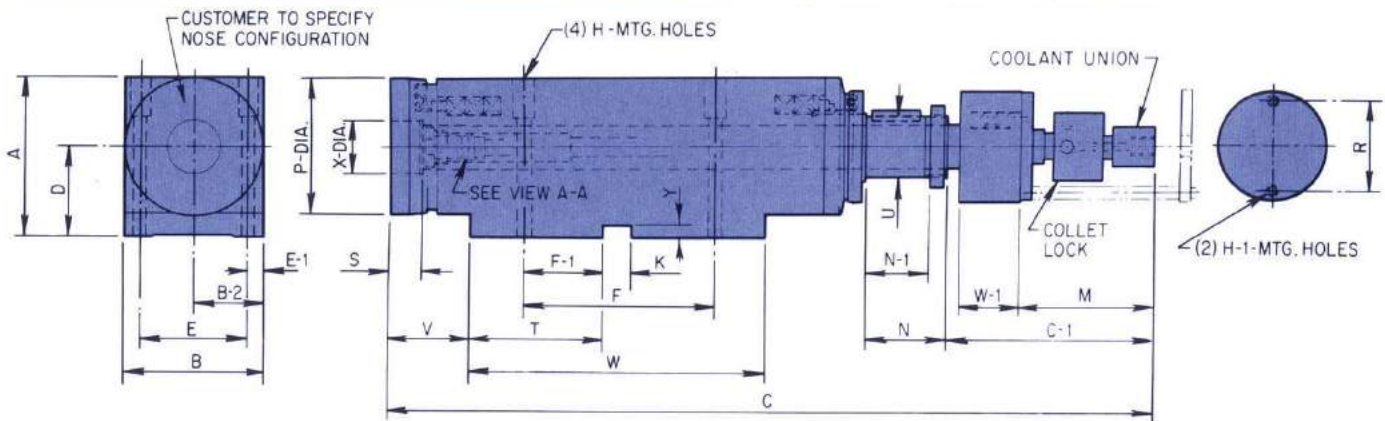



# 4200 MGQ SERIES - Heavy Duty Milling



The 4200MGQ Series of Milling Spindles are recommended in applications for heavy duty metal removal in steel, titanium and aluminum for the aerospace industry.

The Type 4210MGQ Milling Spindle is recommended for replacement of older, lower H.P., manually gear shifted spindles on H & H Wilson, Pratt & Whitney, Rambaudi, Rigid, etc. Profile Milling Machines. These spindles are capable of mounting on 16" centerline distances.

The Type 4213MGQ Milling Spindles are used to retrofit older spar and skin type mills with either 1, 2 or 3 spindles per machine. They have replaced the work-heads on Cincinnati Milacron, Farnham, Giddings & Lewis, Ingersoll, Onsrud, Shin-Nippon, Toshiba, etc.... machines.

## 4210MGQ

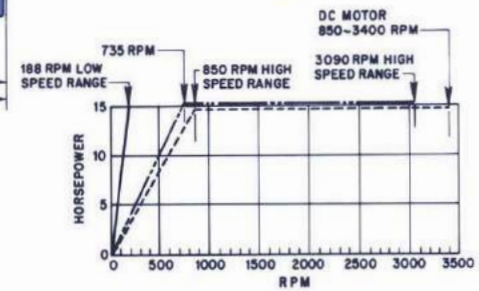
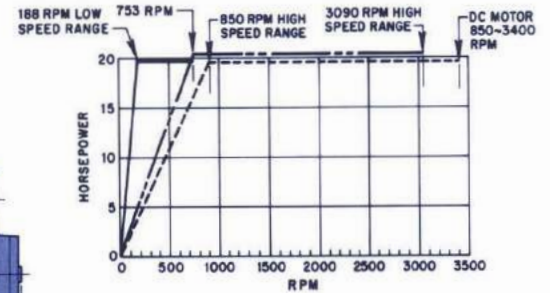
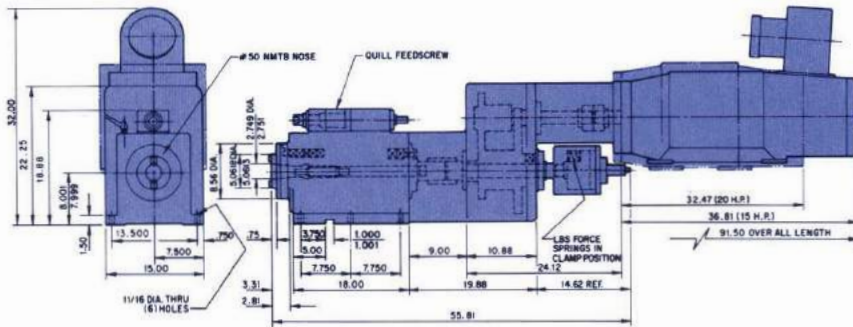

## 4213MGQ

— CONTINUOUS DUTY  
 - - - INTERMITTENT DUTY  
 30 MIN. OPERATION AT  
 FULL LOAD WITH 60 MIN.  
 (AVG.) OFF TIME.

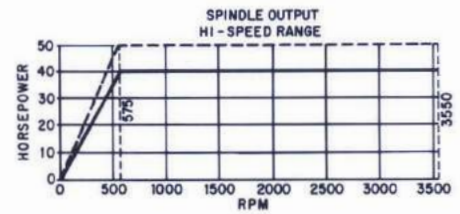
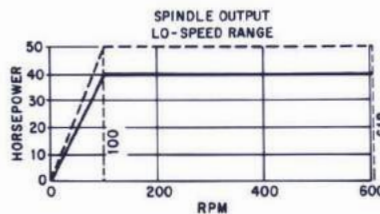
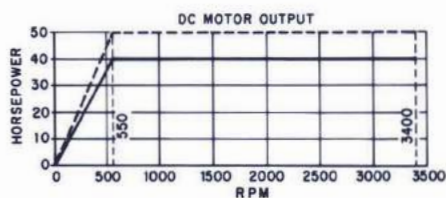
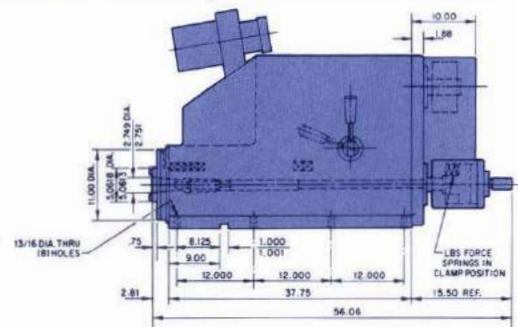
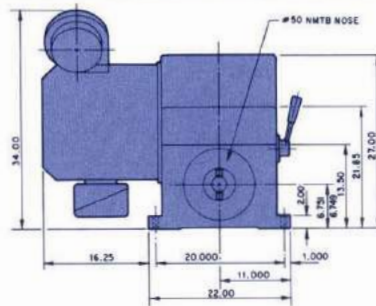





# 6100 SERIES- Motorized Boring and Milling Spindles

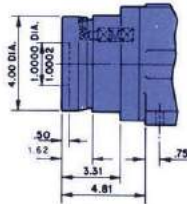
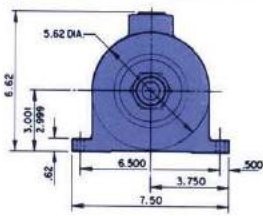

Photo #4075

The SETCO 6100B and 6100M Series of super precision motorized boring and milling spindles are designed with the same high quality standards as the belt driven spindles. The standard milling spindles come equipped with NMTB Nose and hole through arbor except Size 5, which is an integral collet chuck nose. The standard electrical specifications are: 230/460 volts, 3 phase, 60 hertz with special voltages and frequencies as optional. Boring noses are drilled to customer's specifications. Reference Pg. 6 for spindle features and Pg. 37 for optional nose designs. All spindles can be designed to meet your exact application (ref. lettered dimensional drawings bottom of Pg. 31).

The Bearing Sizes shown on each 6100M and 6100B series reflect the exact O.D. shaft size.

## SIZE 5 -T.E.N.V.



BORING

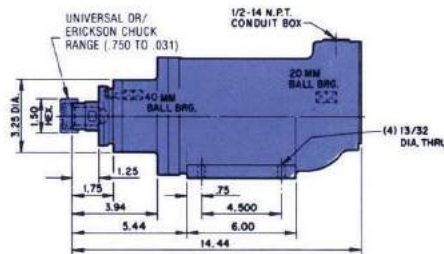

MILLING

*TYPE	H.P.	SPEED	WT.
6100.5-36B/M	1/2	3600	56
6100.5-18B/M	1/2	1800	62
6100.5-12B/M	1/2	1200	72
6100.7-36B/M	3/4	3600	60
6100.7-18B/M	3/4	1800	72
6101-36B/M	1	3600	62
6101.5-36B/M	1 1/2	3600	72

## SIZE 6 -T.E.N.V.

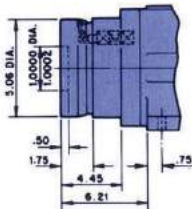
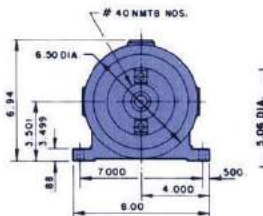

BORING

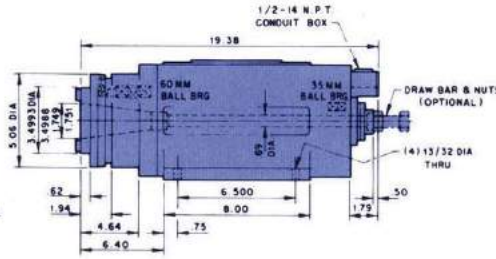

MILLING

*TYPE	H.P.	SPEED	WT.
6101-18B/M	1	1800	120
6101-12B/M	1	1200	130
6101.5-18B/M	1 1/2	1800	130
6102-36B/M	2	3600	130

## SIZE 8 -T.E.N.V.

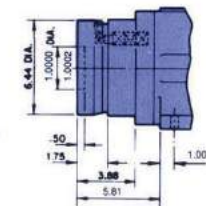
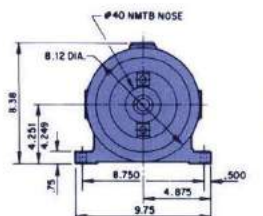

BORING

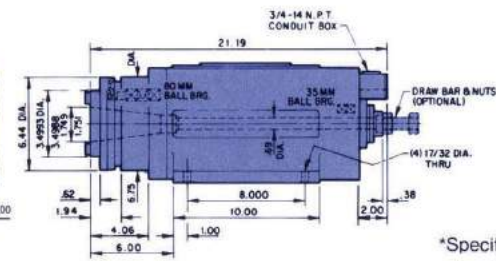

MILLING

*TYPE	H.P.	SPEED	WT.
6101.5-12B/M	1 1/2	1200	200
6102-18B/M	2	1800	200
6103-36B/M	3	3600	190
6103-18B/M	3	1800	210
6105-36B/M	5	3600	200

\*Specify type with a "B"; boring suffix or "M"; milling suffix.



# - Motorized Boring and Milling Spindles

## SIZE 10 –T.E.N.V.

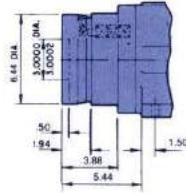
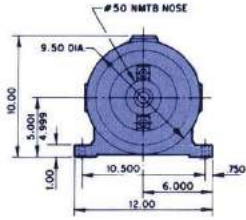

**BORING**

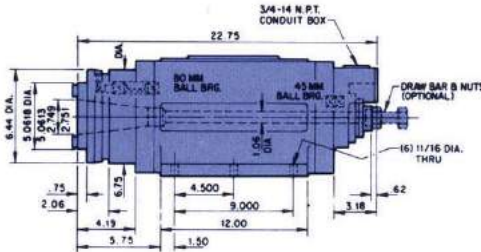

**MILLING**

*TYPE	H.P.	SPEED	WT.
6101.5-09B/M	1½	900	295
6102-12B/M	2	1200	280
6102-09B/M	2	900	310
6103-12B/M	3	1200	295
6105-18B/M	5	1800	295
6105-12B/M	5	1200	320
6107.5-36B/M	7½	3600	295

## SIZE 12 –T.E.F.C.

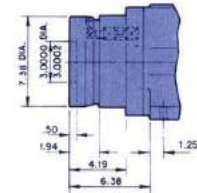
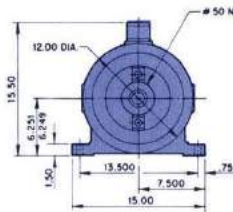

**BORING**

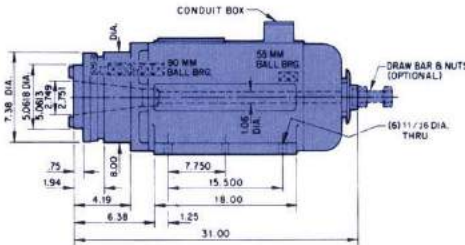

**MILLING**

*TYPE	H.P.	SPEED	WT.
6103-09B/M	3	900	440
6105-09B/M	5	900	450
6107.5-18B/M	7½	1800	450
6107.5-12B/M	7½	1200	445
6107.5-09B/M	7½	900	460
6110-36B/M	10	3600	490
6110-18B/M	10	1800	490
6110-12B/M	10	1200	490
6115-36B/M	15	3600	490
6115-18B/M	15	1800	500
6120-36B/M	20	3600	500

## SIZE 14 –T.E.F.C.

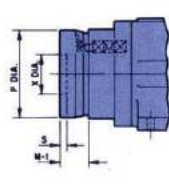
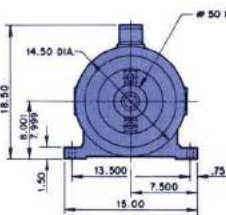

**BORING**

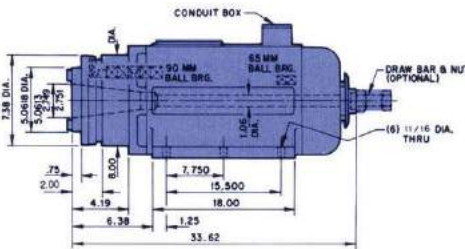

**MILLING**

\*Specify type with a "B"; boring suffix or "M"; milling suffix.

*TYPE	H.P.	SPEED	WT.
6110-09B/M	10	900	580
6115-12B/M	15	1200	600
6115-09B/M	15	900	610
6120-18B/M	20	1800	640
6120-12B/M	20	1200	670
6125-36B/M	25	3600	630
6125-18B/M	25	1800	690
6125-12B/M	25	1200	730
6130-36B/M	30	3600	740
6130-18B/M	30	1800	750

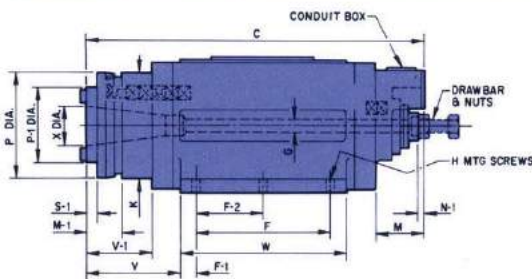

**T.E.N.V.**

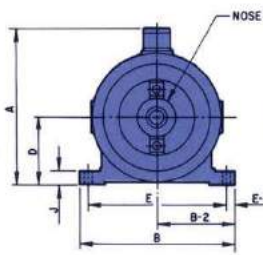

**T.E.F.C.**

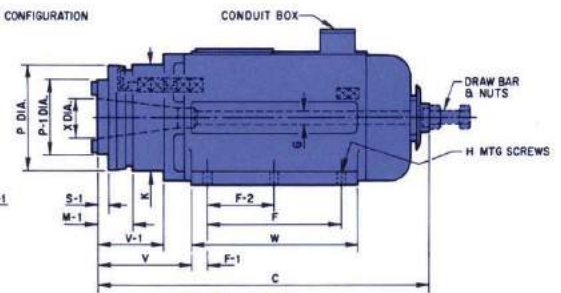





# 6100MLC SERIES - Liquid Cooled Motorized Milling

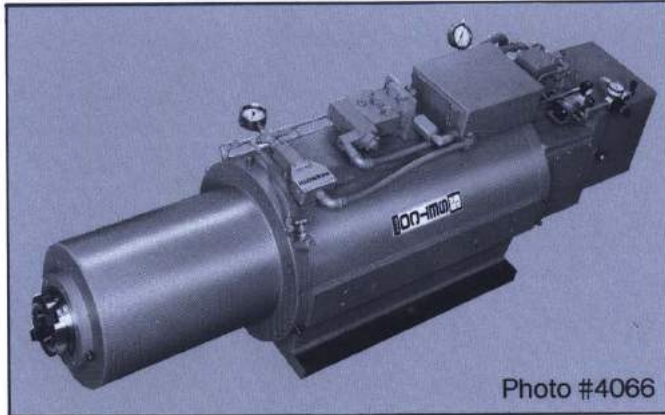
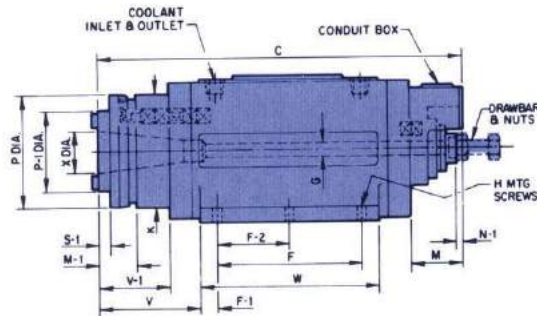
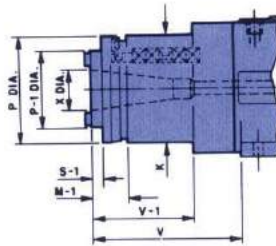
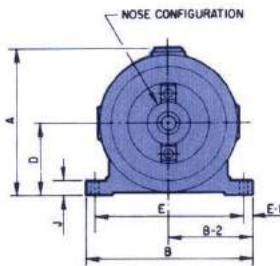

Photo #4066

### COOLANT REQUIREMENTS:

The amount of coolant varies. Normally, six to seven gallons (room temperature) per hour per horsepower are required. The coolant itself depends on the location and type of installation. The cutting tool coolant can be used, run through the spindle first, then to the tool. Anti-freeze may be used for its superior cooling effect. Recirculating or fresh water can be used. For greater effect, the coolant can be refrigerated. In high temperature locations, it may be advisable to cool the bearings as well as the motor.

The SETCO 6100MLC 'Single-Speed' and 6200MLC 'Two-Speed' Series of Heavy Duty Liquid Cooled Super Precision Motorized Milling Spindles offer the same high quality standards as the other spindles in this catalog. The standard Milling Spindles come equipped with NMTB nose, hole through arbor and a front quadruple set of angular contact ball bearings (size 12 and larger). The standard electrical specifications are: 230/460 volts, 3 phase, 60 hertz with special voltages and frequencies as optional. Multi-Speed Spindles are single voltage only. These Series of Liquid Cooled Motorized Milling Spindles are used when space is at a premium or when the Motorized Spindle is installed in a high temperature location. Circulation of a coolant through the housing efficiently dissipates heat from the stator, allowing more horsepower to be produced in a smaller motor package. In the SETCO Design, the stainless steel motor shell is relieved with baffled radial grooves that provide direct contact cooling to the stator housing. The unit is sealed with 'O' rings at each end of the shell to prevent entrance of the coolant to the spindle windings. Reference page 6 for spindle features and page 37 for optional nose designs. All spindles can be designed to meet your exact requirements.



EXTENDED SERIES

STANDARD SERIES

### Size 8 - T.E.L.C.

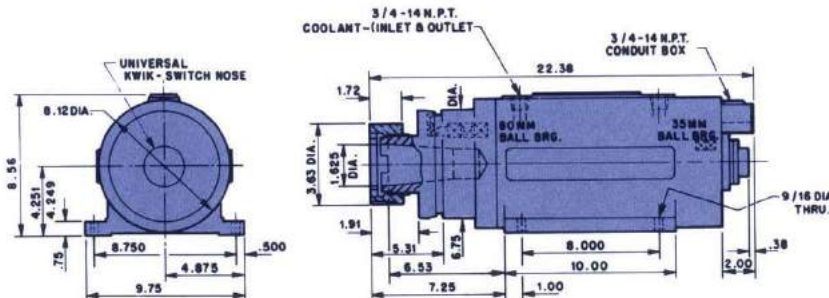

TYPE	H.P.	SPEED	WT.
6102-18MLC	2	1800	200
6103-36MLC	3	3600	190
6103-18MLC	3	1800	210
6105-36MLC	5	3600	200



# -Liquid Cooled Motorized Milling

## Size 10 –T.E.L.C.

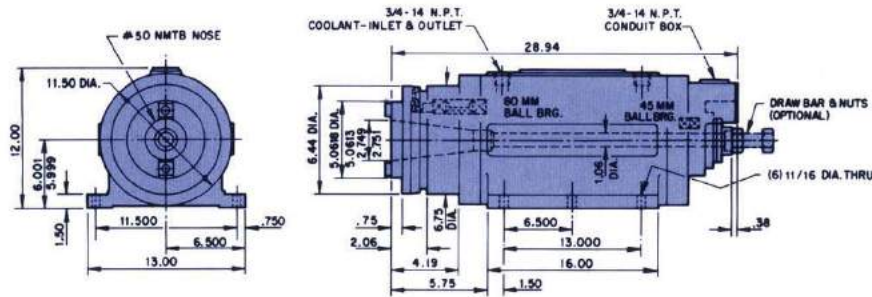

TYPE	H.P.	SPEED	WT.
6110-36MLC	10	3600	335
6120-36MLC	20	3600	350
6125-36MLC	25	3600	350

## Size 12 –T.E.L.C.

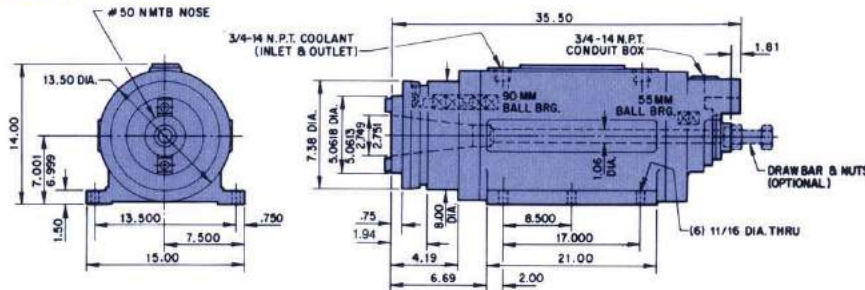

TYPE	H.P.	SPEED	WT.
6120-18MLC	20	1800	495
6125-18MLC	25	1800	495
6130-36MLC	30	3600	495
6140-36MLC	40	3600	495
6150-36MLC	50	3600	495
6225-36MLC	25 / 12 1/2	3600 / 1800	495
6230-36MLC	30 / 15	3600 / 1800	495
6240-36MLC	40 / 20	3600 / 1800	495

## Size 15 –T.E.L.C.

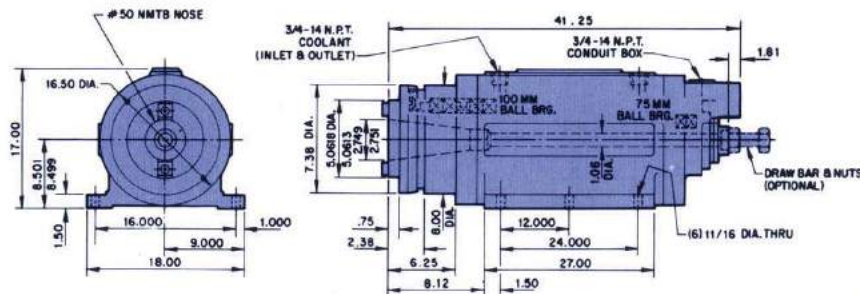

TYPE	H.P.	SPEED	WT.
6130-18MLC	30	1800	772
6140-18MLC	40	1800	810
6150-18MLC	50	1800	838
6160-36MLC	60	3600	810
6175-36MLC	75	3600	810
61100-36MLC	100	3600	810
6250-36MLC	50 / 25	3600 / 1800	810
62100-36MLC	100 / 50	3600 / 1800	810

The 6100MLC and 6200MLC Series of Liquid Cooled Milling Spindles are available with either a Manual Drawbar Assembly, as shown on the above dimensional drawings, or a Power Actuated Drawbar System as shown below. The Power Actuated Drawbar System eliminates manual tightening/loosening of drawbar nuts for tool changing. This Power Drawbar System dislodges the tool by a hydraulically operated cylinder.

The tool is retained by a mechanical spring force using a standard screw-in retention knob by means of a segmented collet (ref. Fig. A below), in the back of the tool body. The tool is held in the taper by a spring force up to 6,000 lb. Hydraulic pressure is required only for tool change. A loss of hydraulic power does not cause a change in tool retention force.

Fig. "A"

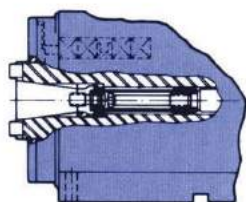
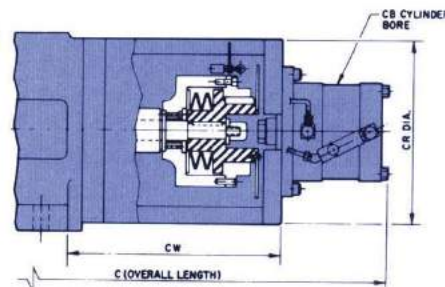

Fig. "B"







# 16100 SERIES- High Speed Milling/Drilling/Routing

SETCO is a proven winner in high speed metal cutting workheads based on many field applications working today. Combined with more rigid machine structures and higher feed rates, production increases of 300% may be achieved over conventional machining systems.

**SETCO High Speed Spindles are designed and built to the highest degree of precision.** All rotating parts plus the outer bearing housings are heat treated and precision ground to assure superior performance. The rotor and shaft assembly are dynamically balanced to displacements as low as .000010 inch. The preloaded angular contact bearings that are used meet ABEC Class 9 specifications. Geometric runouts are also measured in the millionths. SETCO's labyrinth design combined with the air sealing effect of the high pressure oil mist system provides a superior seal from outside contamination. Monitor sensors are provided as safety devices. A solid state power supply makes spindle speed control infinitely variable and, by design, is totally compatible with the most sophisticated requirements.

By utilizing oil mist lubrication to the bearings and liquid cooling to the motor, SETCO can provide heavy duty, ultra-high speed milling/drilling/routing spindles in SETCO frame sizes 5 thru 18 with a horsepower range up to 150 and speed range up to 50,000 R.P.M. Combining these with the GamFior ultra-high speed grinding spindles (reference SETCO Catalog 982) with speed ranges up to 180,000 R.P.M., *SETCO covers the complete spectrum of high speed machining.*

SETCO High Speed Spindles can be ordered individually or as a complete package with power unit,

lubrication and cooling systems. SETCO's Proposal Engineering Group will work with you to recommend the proper equipment to meet your exact application.

## DESIGN CONSIDERATIONS:

While many variations in design are feasible for adaptation to a wide variety of machine tools, certain limitations are necessary depending on speed and horsepower of the spindle.

— Power draw bars for automatic tool changers can be provided for speeds up to 12,000 R.P.M.

— Manual draw bar spindles are available up to 18,000 R.P.M.

— Special Universal "Kwik-Switch," Erickson "Quik-Change" and precision geometrically true collet holders can be furnished for speeds up to 25,000 R.P.M. Speeds above 25,000 R.P.M. must be direct shank mounted into the spindle nose.

All high speed spindle designs go through a critical speed and vibration analysis. These analyses are one of many computer assisted analyses available through our Proposal Engineering Group.

It is important to note that the tooling and tooling adapters used with high speed spindles be of the most precise construction, prebalanced with fixed orientation for spindle acceptance.

It is also important that the machine structure be designed for compatibility with the ultra-high frequency mode of the spindle to prevent undesirable resonance between spindle and machine frame.



Photo #3888

Type 16110-144MLCY Liquid Cooled Routing Spindle with integral collet nose assembly having a collet capacity up to 1" diameter. The spindle is designed to operate from 3600 RPM to 14,400 RPM at 15 HP for machining honeycomb composites and aluminum. These spindles were mounted on 12" centerlines and include a precision ground 10" dovetail slide (ref. Catalog 183) with right angle attachment, bellows and manual gib locks.



Photo #3776

Type 16102-500MLCY Liquid Cooled Routing Spindle rated 2 HP at 50,000 RPM and arranged to operate at a low end of 36,000 RPM. The spindle is arranged with straight shank nose, oil mist lubrication to bearings and dovetail mounting. Spindle used in an aluminum routing operation.



# - High Speed Milling/Drilling/Routing



Type 16130-144MLCY High Speed Liquid Cooled Routing Spindle equipped with quick change tool holder, manual shaft lock, standard air purge lines and regulator, coolant inlet-outlet and arrangement for oil mist lubrication to the bearings. The precision spindle is rated 30 HP/14,400 RPM/230 volts to approximately 3.5 HP/1800 RPM/29 volts.

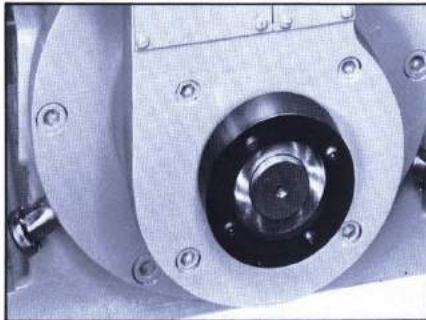

Photo #3951 (bottom)

View shows external balancing ring which allows SETCO to provide final 'Trim' balancing after assembly. This feature is provided at both ends of the shaft for complete 'Four Plane' correction after assembly. This assures the extreme smoothness of operation required for optimum spindle performance.

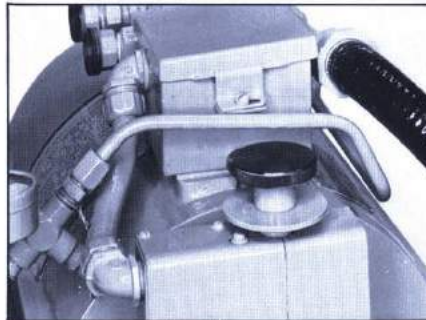

Photo #3951 (top)

This view illustrates the optional manual shaft lock with electronic safety interlock. This system secures the shaft in place during tool changing.

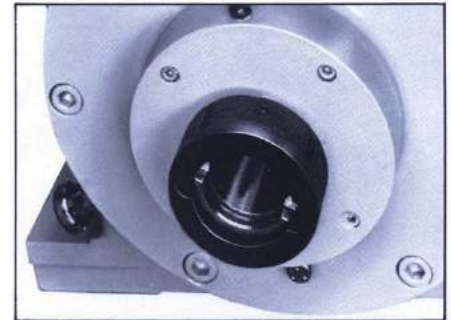

Photo #3952

The quick change tool holder in this view illustrates a Universal 'Kwik-Switch' #300 tool holder precision balanced and aligned for acceptance of customers precision balanced tooling.

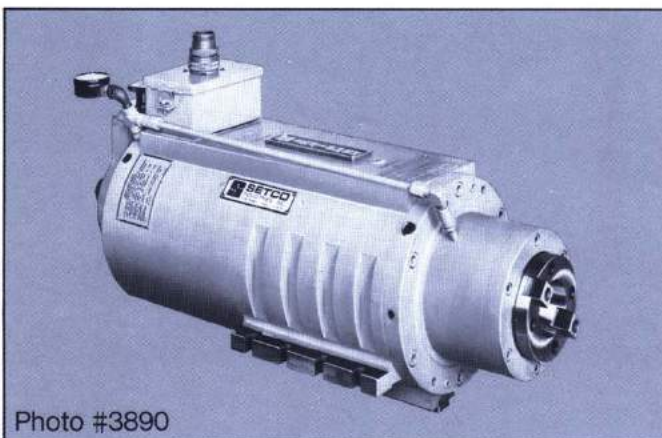

Photo #3890

Type 16115-72MLCY Liquid Cooled Milling Spindle arranged to operate infinitely variable from 450 RPM/4.5 HP/30 hertz to 7200 RPM/24 HP/120 hertz (2/8 pole motor winding). Spindle arranged for dynamic braking through the frequency converter, #50 NMTB Nose, manual draw bar, manual shaft lock with electronic safety interlock, oil mist lubrication to the front and rear bearings and oil mist reclassification system.

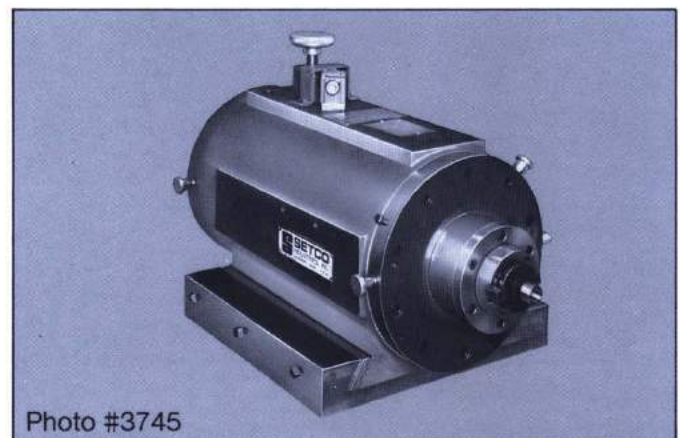

Photo #3745

Type 16120-144MLCY High Speed, Liquid Cooled Motorized Milling Spindle rated 20 HP at 14,400 RPM with oil mist lubrication to the bearings, #40 NMTBA nose, shaft lock with electrical safety interlock, manual drawbar and base having a male dovetail.





# 6100D SERIES - Dovetail Mounted Motorized Spindles



The SETCO 6100D Series of Super Precision Motorized Milling and Boring Spindles are designed with the same high quality standards as the Belt Driven Spindles. They save space, reduce vibration and are ideal for light finishing applications. The elimination of belt or gear drive equipment lowers maintenance and gives better bore geometry through reduced shaft deflection. Manual one inch adjustment with the integral dovetail base is standard. Optional power feeds (reference Photo #3794) and foot-mounted design (reference Photo #4000) are available. The standard 6100D Series has the capability of alternate horsepower and spindle speeds with one spindle size (reference chart below). Optional nose designs are illustrated on page 37. Additional spindle speeds and horsepowers are available upon request.

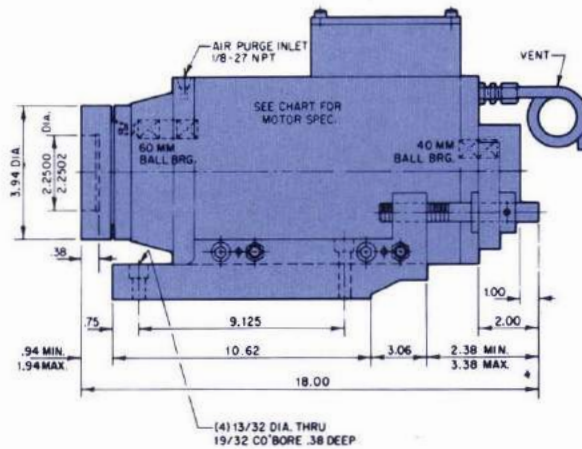
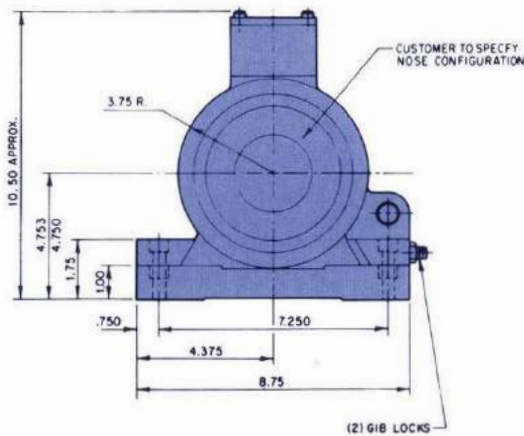
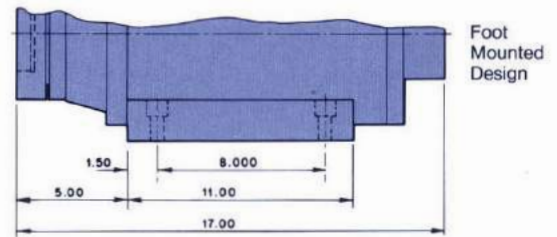

TYPE	MOTOR	PHASE	VOLTS	FREQUENCY
6101-09D	1 HP-900 RPM	3	230/460	60 Hz
6101-18D	1 HP-1800 RPM	3	230/460	60 Hz
6101-36D	1 HP-3600 RPM	3	230/460	60 Hz
6101.5-12D	1.5 HP-1200 RPM	3	230/460	60 Hz
6101.5-18D	1.5 HP-1800 RPM	3	230/460	60 Hz
6102-18D	2 HP-1800 RPM	3	230/460	60 Hz
6102-36D	2 HP-3600 RPM	3	230/460	60 Hz
6103-18D	3 HP-1800 RPM	3	230/460	60 Hz
6103-36D	3 HP-3600 RPM	3	230/460	60 Hz
6105-36D	5 HP-3600 RPM	3	230/460	60 Hz

1. All are size B; TENV Motors  
 2. Standard is air purge and ceramic coated seal journals  
 3. Also available in foot mounted design with foot width 7.75".



# Alternate Nose Designs

All of the Boring and Milling Spindles illustrated in this catalog can be arranged with alternate spindle nose configurations. Described below are only a few of the common alternate nose designs.

## 1. GUN DRILL TYPE NOSE DESIGNS

Can be added to any 4300B Series Spindle on pages 8-11. A variety of nose designs are available on the front end of the spindle arbor to suit the gun drill adapter required for your specific application.

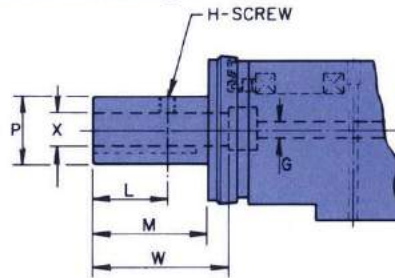

Photo #2122

## 2. LATHE NOSES

Available on many of the 4300B and 4300M Series Spindle. The exact type and size of lathe nose should be specified to select the exact spindle to meet with your specific application.

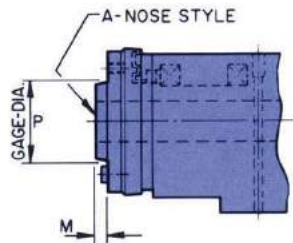

Photo #3788

## 3. UNIVERSAL/ERICKSON KWIK-SWITCH NOSE

The Universal 'Kwik-Switch' and Erickson 'Quick Change' Nose Assemblies can be added to any belt driven or motorized milling spindle design.

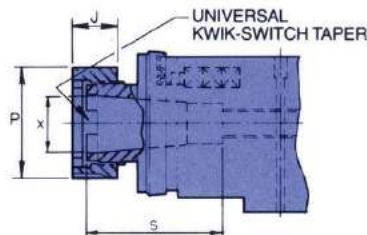

Photo #3695

## 4. ERICKSON/UNIVERSAL COLLET CHUCKS

A wide range of collet sizes are available with the modification of a collet chuck nose. The Type 4302M as shown on page 20 and the 6100 Series (size 5) as shown on page 30 are standard with a collect chuck arrangement.

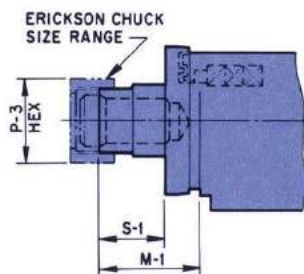

Photo #3888

## 5. LOOSE PIECE PILOT NOSE

Designed specifically when pre-set tooling is required. Available on all 4300B, SP, SX, SH Series and Boring Clusters.

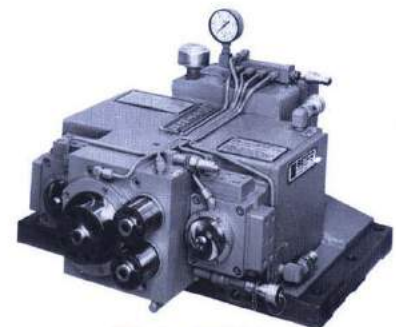
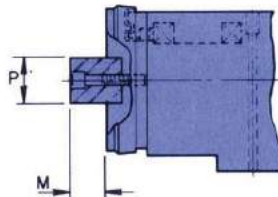
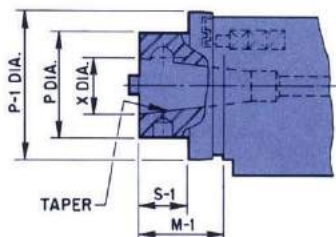

Photo #3801

## 6. DEVLIEG "FLASH-CHANGE" NOSE

This Quick Change Nose Assembly is available on a variety of Boring and Milling Spindles. It offers the convenience of using pre-set tooling.







# Cluster Spindles

Cluster Spindles are used to bore multiple holes when combined standard spindles cannot be mounted to your required part print dimensions. These spindles are manufactured to the same high degree of quality as our standard spindles, with the additional care required to position the centerline to the customer's part print tolerances.

Cluster Spindles have the advantages of performing simultaneous boring operations of a multi-hole part piece with improved and more uniform

accuracy of center distance tolerance between holes. For extreme precision applications, the center distance may be controlled from the effects of thermal expansion to tolerances of plus or minus 2°F. by means of temperature sensing control systems.

When your requirements are for Cluster Spindles, drawings are required showing tolerances of hole centerlines, interference points, tool overhangs, etc... for proper quoting purposes.

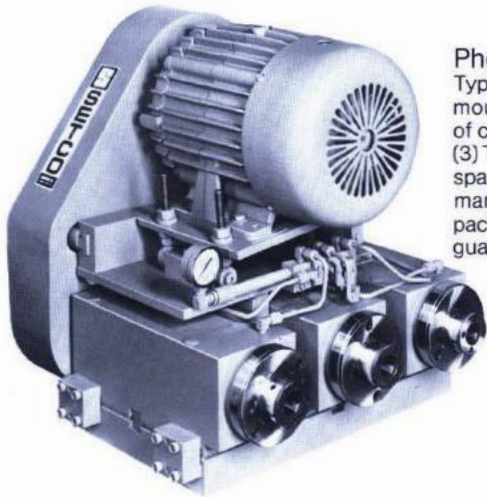

**Photo #3883**  
Type 3CB04Y Three Cluster Bolt-On Spindle Assembly mounted on a sub-plate for mounting to the underside of customer's boring mill arm. This assembly includes (3) Type 4304B Spindles with adjusting blocks, fitting spacers, nose spacers, air purge plumbed to one manifold and a 10 H.P. drive package. The drive package includes belts, pulleys, easy access belt guard and belt tensioning device for adjustment.

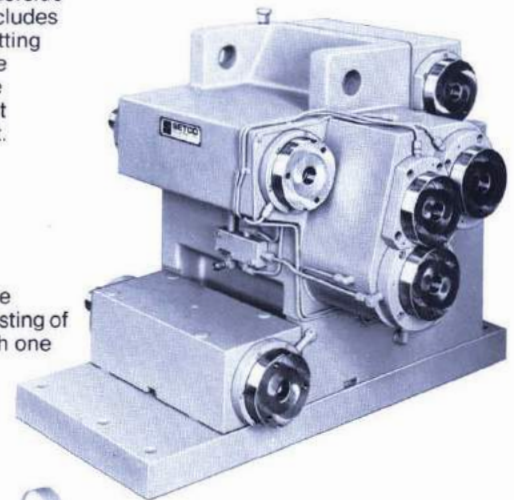
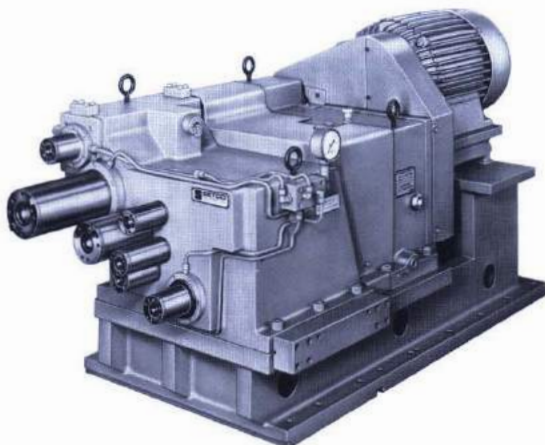

**Photo #3600**  
Type 6CB07GY Super Precision Sub-Plate Mounted Six Cluster Boring Spindle consisting of a (3) cluster integral geared assembly with one input drive shaft and (3) 4307B (Ref. Pg. 9) Boring Spindles separately belt driven with fitting spacers for individual control for pin hole bores.

**Photo #3813**  
Type 3CB04Y Precision Spindle Assembly with an extended top spindle to conform to customer's part. This cluster has three separate input shafts and one convenient air purge inlet with gauge to prevent contaminants from entering spindle.



**Photo #3647**  
Type 7CB05G Super Precision Seven Cluster Geared Spindle System includes intermediate drive package, heating sensors for temperature control, adjusting blocks and fitting spacers, precision integral gear box with single input shaft offering individual speeds at each spindle and lube pump all mounted on one sub-plate assembly.





# Cluster Spindles



**Photo #4083**

This two cluster precision boring assembly is mounted in an integrally cast housing having individual output shafts. The cluster assembly was arranged to accept precision balanced 'Genicon' adapters and tooling. The cluster includes bushing plate, guide bars and pins all actuated by a cylinder assembly to accurately position the spindles for finish boring.



**Photo #3060**

This Type 3CB02Y Super Precision Three Cluster Boring Spindle is sub-plate mounted with a belt power transmission system. This intermediate drive package will operate each spindle through couplings at its appropriate speed.

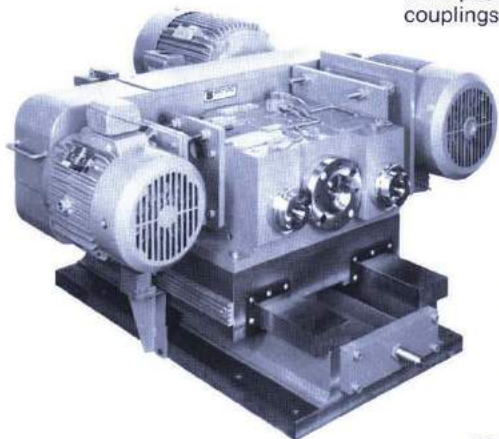

**Photo #4022**

Type 3CB08Y/SHL24HI Three Cluster Spindle/Hardened Steel Way Slide Assembly, consisting of two '03M' size Milling Spindles with #40 NMTBA nose and manual drawbar and one '08B' size Boring Spindle with rotating hydraulic cylinder package for feedout. Nose arranged to mount Modco tooling. Complete assembly mounted on a 24" wide slide with internally mounted hydraulic cylinder package and Turcite coating on way surfaces.



**Photo #3208**

Type 3CB02Y Three Cluster Boring Spindle Assembly with each spindle arbor having its own output shaft.

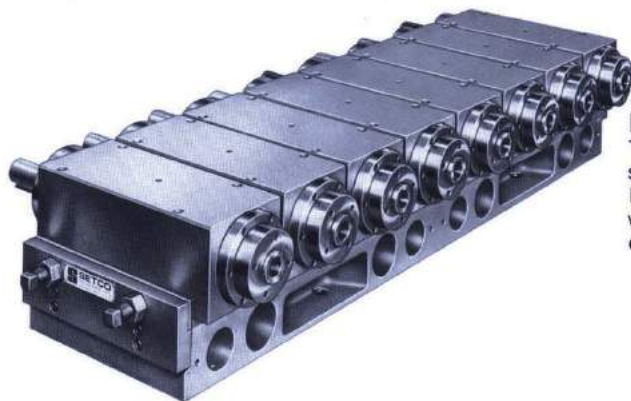
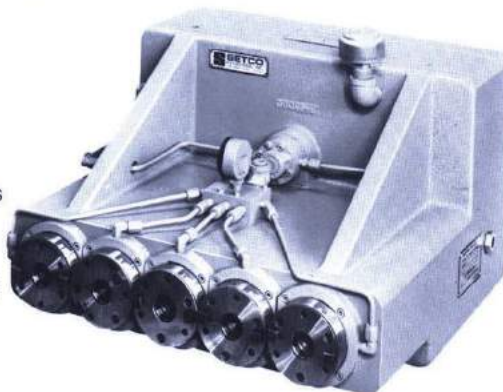

**Photo #3755**

This Multiple Cluster Gun Drilling Assembly consists of (8) Type 4304B Spindle Assemblies (Ref. Pg. 9) mounted on a single sub-plate assembly with fitting spacers and adjusting blocks for exact positioning of each spindle centerline.

**Photo #3733**

This Super Precision Five Cluster Geared Spindle includes an intermediate gear box with one input shaft offering the ability to have different operating spindle speeds. Included are double drive keys, air purge with pressure gauge, flow gauge and lube pump to circulate oil through the integral gear box.







# Spindle Accessories

In addition to our broad line of standard boring and milling spindles, SETCO offers a variety of accessories to compliment or enhance their usefulness and versatility. These accessory

items are normally available on all SETCO spindles and are built to the same high standards of quality and workmanship.

## 1. Power Actuated Linear Draw Bar

For applications where "Quick Release" of the tool adaptor is desired, a linear spring loaded draw-bar similar to the illustration may suit your requirements.

Tool adaptor is gripped through an adaptor retention knob by means of a segmented collet. Retention force is provided by either Belleville disc springs (shown in illustration) or compression springs.

Collet release is provided by a linear hydraulic or pneumatic cylinder (cylinder not shown and may be furnished by SETCO or customer. Cylinder type is determined by the application and retention force required to suit the job). The indicating disc illustrated provides a reference surface for a system interlock for a switch actuation to indicate that the draw-bar is open.



Photo #3815

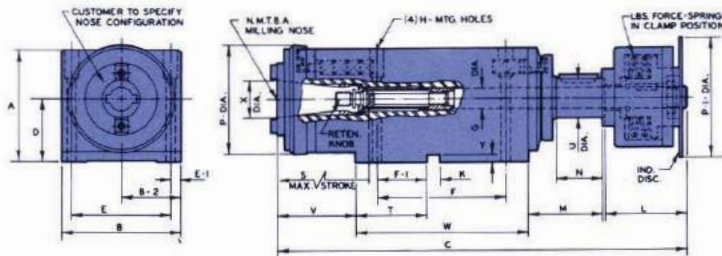

The maximum stroke "S" is the amount of stroke required to release the collet and is a variable depending on specified cutter geometry.

## 2. 'OTT' Power Draw Bar System

The 'OTT' power draw bar system is a compact design with high clamping power. This system does not load the spindle bearings and is capable of operating at high spindle speeds. The 'OTT' power draw bar makes allowance for the demand for short tool-changing cycles and ease of handling.

These draw bar units are available in #40, #45 and #50 milling tapers in either the solid or coolant through design.



Photo #4104

The spindle nose type and tooling specifications are required from the customer.

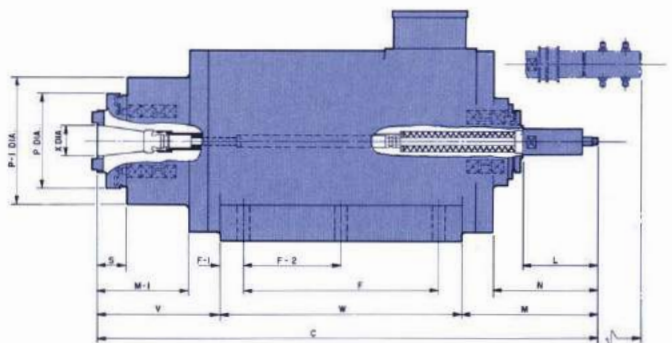
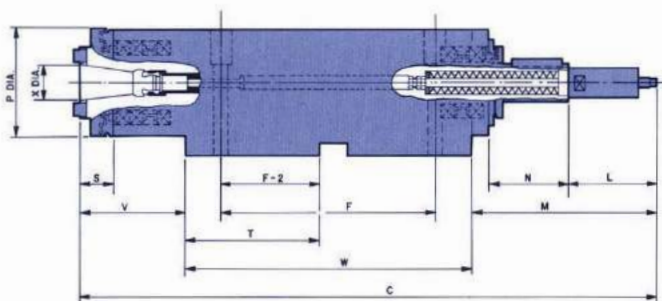



# Spindle Accessories

## 3. Rotating Cylinder

The Rotating Cylinder provides a means to actuate a draw-bar through the rotating shaft. The design incorporates a drive pulley, adjustable positive stop collars for stroke control, rotating cylinder, and position sensing limit switches.



Photo #3861

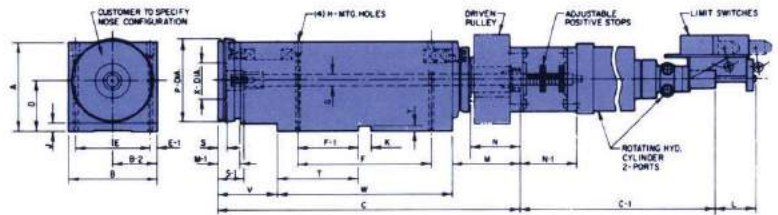

## 4. Adjustable Motor Mounting Plates

Two types of motor mounting systems for the 4300 series rectangular style housings are available:

—Type 'A' design (ref. Photo #3715) is a multiple mounting plate construction designed for each specific application with motor frame size and spindle speed

dictating the exact size. This type is recommended when motor mounting to the side or rear of the spindle is not permitted.

Type 'A'



Photo #3715

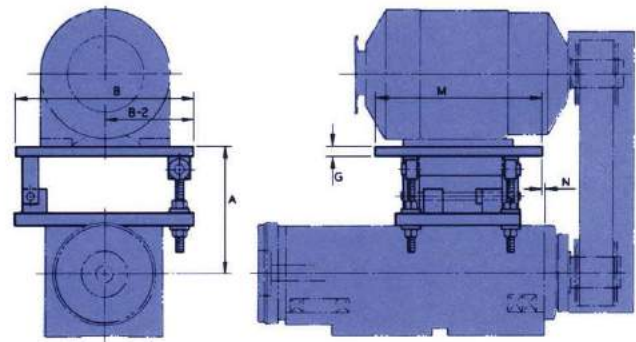

—Type 'B' design (ref. Photo #4088) is an integral motor mounting bracket/belt guard system capable of being

positioned in one of many mounting attitudes. This design uses 'C' flange mounted motors.

Type 'B'

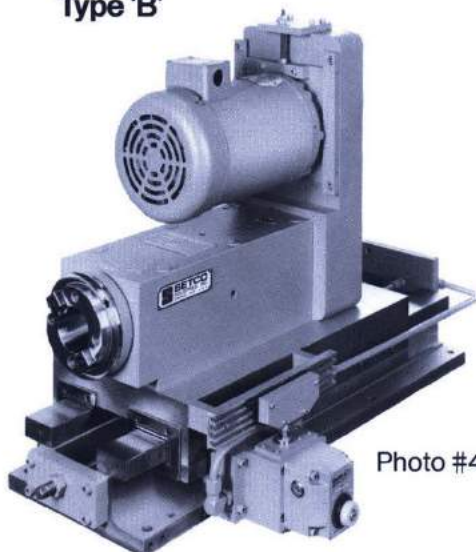
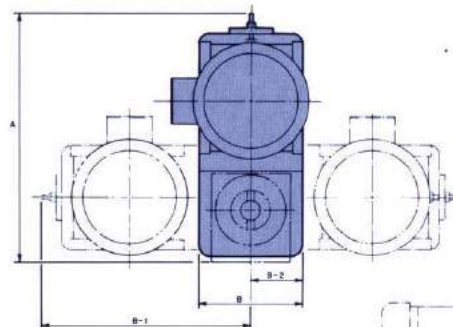
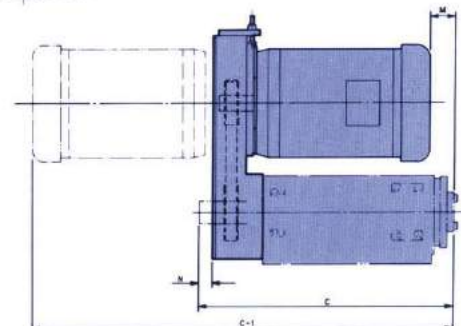

Photo #4088



**Note:** Specify Motor Mounting Attitude when ordering.







# Spindle Accessories

## 5. Draw Bar Support Bushings

Bronze bushings or hardened liners are precision sized to provide a bearing support for a linear actuated draw-bar (Application Reference: Feed Out Heads, Tool Compensation Attachments, etc.).

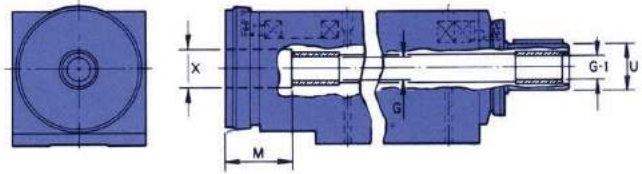

## 6. Outboard Bearing Supports

Used in applications that require outboard support where excessive cutters or tool overhang conditions are present. Each outboard bearing support is designed to the customer's requirements.



Photo #3728



Photo #3923

## 7. Rotating Coolant Unions

Available on all belt driven milling and boring spindles. These rotating coolant unions allow the coolant to enter in the rear of the shaft through the arbor to the tool.

**Figure #1**—Illustrates an externally mounted pilot design.

**Figure #2**—Illustrates an 'in-the-shaft' mounted design.

Figure #1

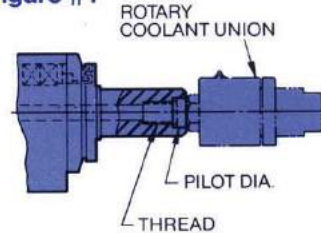
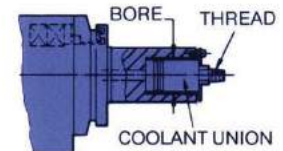

Figure #2



## 8. Oil Mist Lubricators

All SETCO oil mist lubrication systems are designed, calibrated and approved to operate with a particular precision spindle assembly. These systems permit higher operating speeds and the use of larger bearings for increased rigidity and power capabilities.



Photo #4142

## 9. Feed Force Monitoring Systems

Various types of spindle monitoring systems are available for turning, drilling, milling, boring and tapping applications. Shown below are two types of monitoring systems using sensors to the bearings for either belt driven or

direct drive motorized spindles. SETCO utilizes a unique design concept in incorporating a rear linear bearing to eliminate the effect of hysteresis with the rear bearing fit.

PROMESS DESIGN

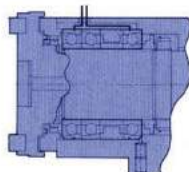

SANDVIK DESIGN

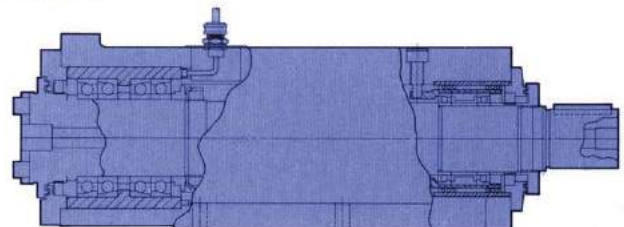



# Application Photos



**Photo #3991**  
Type 4209MY Super Precision Milling Spindle with Timken 'Hydra-Rib' design bearings. Housing is arranged for recirculating oil cooling and includes linear power drawbar assembly.



**Photo #4103**  
This precision spindle/slide assembly consists of a motorized Size 6 milling spindle rated 2 H.P. at 3600 R.P.M. with universal 'Kwik-Switch' nose. Spindle is precision keyed and aligned to a Type SHL12FGD, 12" wide, Hardened Steel Way Slide equipped with precision ground ball screw and double preloaded ball nut which is directly coupled to a motor with right angle gear box.



**Photo #4080**  
Precision milling spindle/slide assembly consisting of a 4304M Spindle with #40 NMTB nose and integral motor mounting bracket/belt guard, drive system which is mounted to a manual 10" wide dovetail slide assembly.



**Photo #4015**  
Type 4305BY Boring Spindle Assembly arranged with an A2 6" Lathe Nose, 1.56" hole through arbor for coolant flow, SMW chuck assembly and high speed rotary jet cylinder, special pulley/cylinder adapter and draw tube for feeding 1" diameter stock.

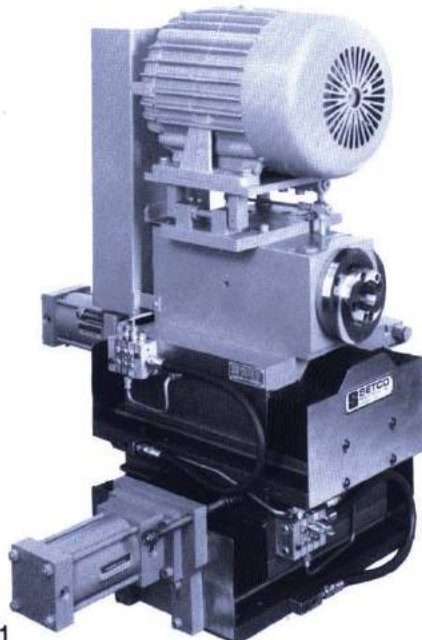

**Photo #4001**  
Type 4305M/SHL12H Special Milling Spindle/Compounded Hardened Steel Way Slide Assembly with externally mounted hydraulic cylinder package, bellows and plumbing to a manifold junction for acceptance of customer's automatic lubrication system.

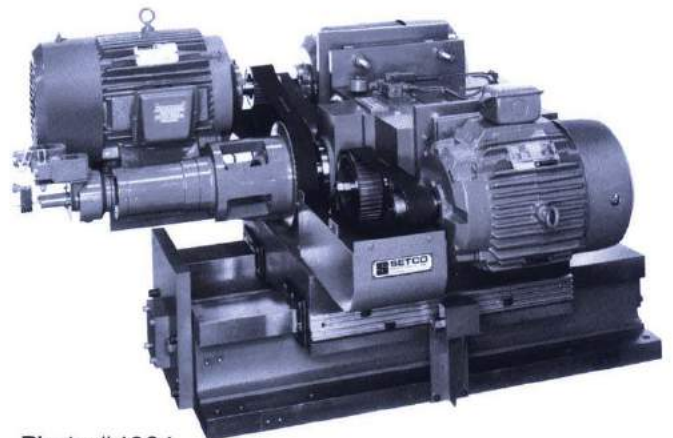

**Photo #4024**  
Special Cluster Spindle/Hardened Steel Way Slide Assembly illustrating a rotating hydraulic cylinder package and individual drive packages for each spindle assembly all mounted on a 24" wide slide with internally mounted hydraulic cylinder package.





# Engineering Section

The information in this section has been compiled to assist you in applying the Precision Spindles in this catalog to your specific requirements. It should be noted that all this information is generally accepted as good practice, but is to be tailored to individual specifications. The following information is intended to provide a quick and simple means of approximating application requirements for Milling, Boring, Turning, and Drilling Spindles. We recommend consulting a cutting tool specialist to obtain best results for final selection. This section contains formulas for calculations of approximate horse-powers, speeds, feed rates, etc. On special applications, we invite you to use the services of the SETCO Proposal Engineering or Sales Engineering Departments. All of the standard spindles in this catalog can be modified to meet your exact specifications. We ask that you reference the letter dimensional drawings on page 7 for the Belt Driven Boring/Milling Spindles, page 31 for the T.E.N.V. and T.E.F.C. Motorized Boring/Milling Spindles and page 33 for the T.E.L.C. Motorized Milling Spindles when specifying your modifications. The basic Boring/Milling Spindle selection chart, located on pages 4 and 5, will assist you in proper spindle selection for your particular application. The standard features related to the spindles in this catalog are listed on page 6.

The major factor in selecting the proper spindle for your particular machining operation is the amount of power required to do the job. This power requirement, as recommended by SETCO, is defined as the **Unit Power Technique**. The **Unit Power Technique** utilizes published unit power requirements for the machining operation relative to the material of the cutter and the material of the work piece. Before you determine the Unit Power, you must first define your cutting speed and feed rate requirements. The cutting speed and feed rate are determined by the **material and geometry of the cutter, material and hardness of the work piece and the type of machining operation**. The chart below approximates the proper cutting speeds and feed rates; however, the best source for final selection would be to consult a cutting tool manufacturer or specialist. Cutting speeds and feed rates are continually being updated and cutter manufacturers should have the latest information. After locating the appropriate speed and feed rate from the chart below, select the resultant **Unit Power**. After determining your **Unit Power**, you will be able to utilize the selection formulas to size the proper spindle.

## AVERAGE UNIT POWER REQUIREMENTS

MATERIAL	HARDNESS (Bhn)	MILLING/TURNING/BORING						DRILLING/GUN DRILLING		
		FEED—(Milling .005-.012 ipt)—(Boring/Turning .003-.020 ipr)						(FEED .002-.008 ipr)		
		*Unit Power hp/in <sup>3</sup> /min.		±SPEED—Feet Per Minute				*Unit Power hp/in <sup>3</sup> /min.	±SPEED Feet Per Minute	
		Milling	Turning & Boring	High Speed Steel Tool	Carbide Tool		Ceramic Tool Turning & Boring Only		Drilling (H.S.S. Tool)	Gun Drilling (Carbide Tool)
				Uncoated	Coated					
ALUMINUM ALLOYS	30-150	0.32	0.25	500-1200	500-2500	—	500-3500	0.16	25-375	450-700
CAST IRONS Gray, Ductile & Malleable	110-190	0.6	0.7	25-330	70-880	155-1300	300-2000	1.0	25-130	115-450
	190-320	1.1	1.4	25-200	40-510	105-775	300-1500	1.6	25-290	90-360
COPPER ALLOYS	10-80R <sub>B</sub>	0.64	0.64	90-550	150-1320	—	—	0.48	50-200	350-600
	80-100R <sub>B</sub>	1.0	1.0	100-600	160-1430	—	—	0.8	60-225	375-650
HIGH TEMP. ALLOYS Nickel & Cobalt Base	200-360	2.0	2.5	5-30	10-100	400-600	—	2.0	5-55	50-80
	Iron Base	1.6	1.6	10-60	60-155	—	—	1.2	20-25	100-150
MAGNESIUM ALLOYS	40-90	0.16	0.16	550-1000	1400-2500	—	—	0.16	140-365	650
NICKEL ALLOYS	80-360	1.9	2.0	15-140	20-395	—	—	1.8	30-70	60-200
PRECIPITATION HARDENING STAINLESS STEEL	150-450	1.5	1.4	25-110	90-390	155-575	200-950	1.2	20-30	80
REFRACTORY ALLOYS Tungsten	321	2.9	2.8	70-150	55-550	—	—	2.6	60-225	—
	Molybdenum	229	1.6	2.0	60-100	205-280	—	1.6	75-110	—
	Columbium	217	1.5	1.7	55-100	140-280	—	1.4	50-80	—
	Tantalum	210	2.0	2.8	40-75	60-95	—	2.1	50-55	—
STAINLESS STEEL, WROUGHT & CAST Ferritic, Austenitic and Martensitic	135-275	1.4	1.3	45-150	125-440	190-650	350-1700	1.1	45-75	165-280
	30-45R <sub>C</sub>	1.5	1.4	30-90	90-325	140-475	175-1100	1.2	25-55	100-180
STEELS, WROUGHT AND CAST Plain Carbon Alloy Steels Tool Steels	85-200	1.1	1.1	50-375	190-950	300-1375	500-2600	1.0	45-150	250-750
	35-40R <sub>C</sub>	1.5	1.4	35-140	100-525	175-785	350-1600	1.4	25-65	100-275
	40-50R <sub>C</sub>	1.8	1.5	20-110	65-440	190-650	200-800	1.7	15-65	65-225
	50-55R <sub>C</sub>	2.1	2.0	20-60	45-190	—	200-600	2.1	10-100	—
	55-58R <sub>C</sub>	2.6	3.4	—	40-110	—	100-400	2.6	50-75	—
TITANIUM	250-375	1.1	1.2	20-110	40-325	—	—	1.1	20-55	65-180

NOTE: Compiled and reprinted from the MACHINING DATA HANDBOOK, 3rd Edition, by permission of the Machinability Data Center. © 1980 by Metcut Research Associates Inc.

\*Multiply unit power by 1.3 when utilizing a dull tool.

‡These recommendations are intended to be used as a starting point and may be varied to fit different operating conditions or requirements.



# Engineering Section

Once you have determined the **Unit Power**, cutting speed and feed rate through the chart, you must calculate the horsepower and spindle speed through the corresponding formulas specified below. You can obtain a relative torque value by dividing the horsepower by the speed, yielding HP/Rev. Spindles should be selected on the basis of having a HP/Rev. rating equal to or greater than the load HP/Rev. and having a maximum speed rating equal to or greater than the operating speed. Each precision spindle has its own HP/Rev. value. This information along with tool overhang conditions, bearing bore sizes, etc...., (ref. pages 4 and 5) should determine your spindle requirements.

**Use lower speeds for:** abrasive and hard materials, sandy castings, heavy work pieces, heavy cuts, rigid set-ups,

high nickel content alloys; where excessive cutter wear occurs.

**Use higher speeds for:** better finishes, softer materials, lighter cuts, fragile work pieces, a weak set-up, thread milling, sawing where a smaller cutter diameter is indicated.

**Use faster feeds for:** heavy roughing cuts, with a rigid set-up and heavy work piece, for light slab milling, abrasive materials, for scale-covered surfaces and on easily machined metals when chattering occurs.

**Use the slower feed for:** for loosely-held work pieces, weak milling cutters, better finishes, deep slotting cuts and where "stringy" chips are formed.

**Roughing cuts:** select heavier feeds and lower speeds.

**Finishing cuts:** select lighter feeds and higher speeds.

## FORMULAS FOR SELECTING SPINDLES

MILLING	BORING/TURNING	DRILLING
$RPM = 3.82 \times \frac{Vc}{Dm}$	$RPM = 3.82 \times \frac{Vc}{Dt}$	$RPM = 3.82 \times \frac{Vc}{Dd}$
$fm = ft \times n \times RPM$	$fm = fr \times RPM$	$fm = fr \times RPM$
$Q = w \times d \times fm$	$Q = 12 \times d \times fr \times Vc$	$Q = \frac{\pi \times Dd^2 \times fm}{4}$
$HPs = Q \times P$	$HPs = Q \times P$	$HPs = Q \times P$
$HPm = Q \times P/E$	$HPm = Q \times P/E$	$HPm = Q \times P/E$
$t = L/fm$	$t = L/fm$	$t = L/fm$
$Ts = 63030 \times \frac{HPs}{RPM}$	$Ts = 63030 \times \frac{HPs}{RPM}$	$Ts = 63030 \times \frac{HPs}{RPM}$

## EXPLANATION OF FORMULAS

d = depth of cut, inches	HPm = horsepower at motor
Dd = diameter of drill, inches	HPs = horsepower at spindle
Dm = diameter of milling cutter, inches	L = length of cut, inches
Dt = diameter of work piece in turning or diameter of boring cutter, inches	n = number of teeth in cutter
E = efficiency of spindle drive (consult motor manufacturer for firm value, as a guideline use approximately 80-90%)	P = Unit Power, HP per in. <sup>3</sup> per minute
fm = feed rate, inches per minutes	Q = rate of metal removed, in <sup>3</sup> /min.
fr = feed, inches per revolution	RPM = revolutions per minute
ft = feed, inches per tooth	t = cutting time, minutes
	Ts = torque at spindle, inch-pounds
	Vc = cutting speed, feet per minute
	w = width of cut, inches

Example #1: Customer's end mill operation using a 1/2" diameter, 4 tooth, 2" long high speed steel (sharp) tool doing a 1/8" roughing cut in 35 Rc alloy steel.

Step 1—Locate material of cutter, material and hardness of work piece and type of machining operation on chart.

Step 2—Select the corresponding speed (fpm) and feed (ipt) from chart. NOTE: Use guidelines as noted above to help determine the high and low end of approximated values.

Step 3—After locating your appropriate speed and feed rate from chart, select the resultant Unit Power value.

Step 4—In acquiring your speed (35 s.f.p.m.), feed rate (.012 ipt) and Unit Power (1.5 hp/in<sup>3</sup>/min) values, you are now ready to use the milling selection formula to determine your HP/Rev. rating which is used to size your Precision Spindle.

$$RPM = 3.82 \times \frac{Vc (35 \text{ fpm})}{Dm (.50)} = 267 \text{ RPM}$$

$$fm = ft (.012) \times n (4) \times RPM (267) = 12.816 \text{ ipm}$$

$$Q = w (.5) \times d (.125) \times fm (12.816) = .801 \text{ in}^3/\text{min.}$$

$$HPs = Q (.801) \times P (1.5) = 1.2 \text{ HP}$$

$$HPm = Q (.801) \times P (1.5)/E (.80) = 1.5 \text{ HP}$$

$$Ts = 63030 \times \frac{HPs (1.2)}{RPM (267)} = 283 \text{ lbs. in}^2$$

$$HP/Rev. = 1.2/267 = .0045 \text{ HP/Rev.}$$

\*SPINDLE SIZE 4304M RATED 500 lbs. in<sup>2</sup>, .008 HP/REV. with rubbing seal

\*NOTE: Specify spindle mounting attitude and verify spindle size in reference to "tool overhang" through selection chart located on pages 4 and 5 when ordering.

Example #2: Customer's boring operation using a 1 3/4" diameter cutter, 4" long, uncoated carbide (sharp) tool doing a 3/4" finishing cut in aluminum.

Follow steps 1 through 4 as above to determine speed, feed rate, and Unit Power. Then use the boring selection formula to determine your HP/Rev. rating.

$$RPM = 3.82 \times \frac{Vc (2500 \text{ fpm})}{Dt (1.75)} = 5457 \text{ RPM}$$

$$fm = fr (.003) \times RPM (5457) = 16.4 \text{ ipm}$$

$$Q = 12 \times d (.75) \times fr (.003) \times Vc (2500) = 67.5 \text{ in}^3/\text{min.}$$

$$HPs = Q (67.5) \times P (.25) = 16.87 \text{ HP}$$

$$HPm = Q (67.5) \times P (.25)/E (.80) = 21.1 \text{ HP}$$

$$Ts = 63030 \times \frac{HPs (16.87)}{RPM (5457)} = 195 \text{ lbs. in}^2$$

$$HP/Rev. = 16.87/5457 = .003 \text{ HP/Rev.}$$

\*SPINDLE SIZE 4304B RATED 500 lbs. in<sup>2</sup>, .008 HP/REV. with labyrinth seal.

\*NOTE: Specify spindle mounting attitude and verify spindle size in reference to "tool overhang" through selection chart located on pages 4 and 5 when ordering.

NOTE: Specifications and design subject to change without notice.





# Application



Photo #3730

Type 6081MLC2Y Liquid Cooled Two Speed Milling Spindle rated 100/50 HP at 3600/1800 RPM with a 20" long extended front end. Spindle used in a spar mill operation and includes hydraulically operated disc brake with safety interlock, two position tool orientation system and linear draw bar with mushroom holder.



Photo #3880

Type 16049MLC2Y Liquid Cooled Two Speed Profile Milling Spindle designed to mount to customer's existing five axis machine. Spindles are arranged to operate with 40/20 HP at 3600/1800 or 7200/3600 RPM.

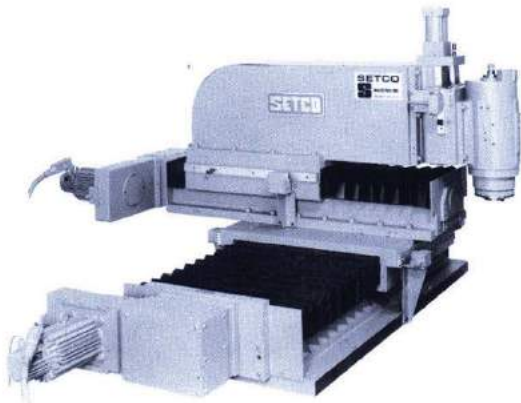

Photo #4089

Three axis slide assembly with a vertical nose down—side wall mounted Type 6105-18M Motorized Spindle rated 5 H.P. at 1800 R.P.M. Spindle mounted to a 12" wide hardened steel way slide with externally mounted hydraulic cylinder package. 'X' and 'Y' axis include linear recirculating roller bearing guides and standard motor drives with servo.



Photo #4097

Block style milling spindle arranged with a T.A.D. motor adjusting plate and drive package mounted to a SHL12 (12" wide) Hardened Steel Way Slide with an internally mounted hydraulic cylinder package.

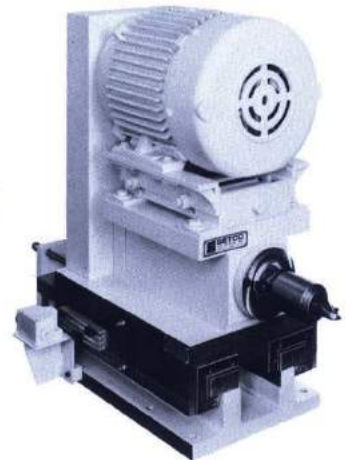

Photo #3840

Type 2CRM-10/10Y Two Cluster Right Angle Milling Spindle (ref. pages 22 & 23). Assembly mounted horizontal side wall with input drive shafts in 'up' position.



# Application

**Photo #4156**

Servo Spindle, speed range 2000-20,000 RPM, 50 HP @ 20,000 RPM. Includes power draw bar, tool orientation, promess BRG sensor and 40 taper nose.



**Photo #4126**

Spindle type 4305 M with 'ott' power draw bar and coolant thru, mounted to SHL 12 HI hardened steel way slide with internal hydraulic cylinder.

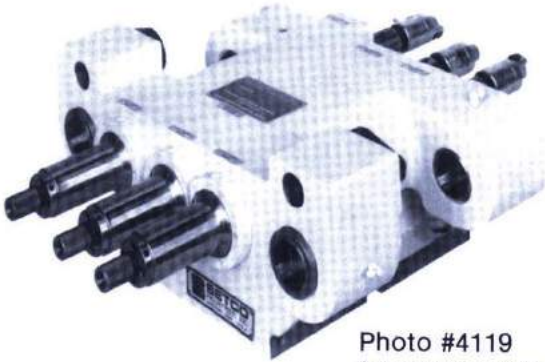
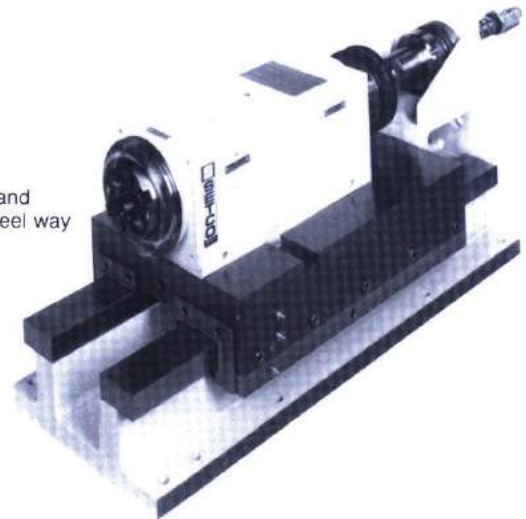

**Photo #4119**

3 three cluster boring/reaming spindle with "stieber chuck" and Rotating Coolant Union. Guide bar bushing in support housing for attachment to customer bushing plate.



**Photo #4131**

Spindle type 4213 BG parallel geared with Cast Iron Motor Mtg. Type 'B'. Mounted to SHL 18 HI hardened steel way slide with heavy duty internally mounted hydraulic cylinder, tapered gib and keeper locks.



# YOUR SINGLE SOURCE

For Repair, Rebuild, Exchange, New – Plus a Total Range of Related Services to Enhance Your Just-In-Time Manufacturing

## PRODUCTS



Dovetail Slides



Linear Recirculating Bearing Slides

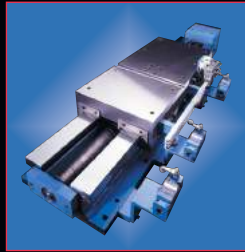

Hardened Steel Way Slides



Grinding Spindles and Accessories



Boring and Milling Spindles



Sentry Belt-Driven Spindles



Spindle/Slide Combinations



3-Axis Machining Modules



ProMetrix Belt-Driven Spindles



Smart Closed-Loop Motorized Spindles

## SERVICES



Total Solution Team Engineering



Field Service and Vibration Analysis



State-of-the-Art Slide Repair

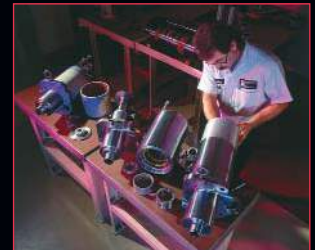

Leading Edge Spindle Repair



Complete In-House Manufacturing, Assembly



Hands-On Spindle and Slide Repair Training

# SETCO™

5880 Hillside Ave. • Cincinnati, OH 45233

Tel: 513/941-5110 • 800/543-0470

Fax: 513/941-6913 • [www.setcousa.com](http://www.setcousa.com)